

MISSONI

HOME COLLECTION

ARREDO E TESSUTI
FURNITURE AND FABRICS
2023

MISSONI

HOME COLLECTION

LIVING ROOM

8 ARTWORK "8"



10 ARTWORK "16"



12 PANETTONE



14 CIAMBELLA



16 SPIDER



18 MAMA SOFT



20 GRAVITÀ



22 INNTEL



24 TEKTONIK



26 CORDULA POLTRONA



28 GRANDMA



30 MILADY



32 ART GLASS



34 CORDULA TAVOLINO



38 GEMMA



40 PUNTASPILLONE



DINING ROOM

42 FRAMED MIRROR



44 MISS WOOD TAVOLO



46 MISS WOOD SEDIA



48 MISS SEDIA



50 MISS SGABELLO



BEDROOM

52 INNTIL LETTO



54 ONIRO



58 SCREEN



60 PONENTE



OUTDOOR

64 TEKTONIK OUTDOOR



66 VIRGOLA SOFT



68 JALAMAR OUTDOOR



70 REGISTA



FABRICS

72 INDOOR

92 OUTDOOR

98 TENDE

LIVING ROOM



ARTWORK "8"

ARTWORK ARTWORK

1B4M000120



L'inconfondibile patchwork Missoni diventa un oggetto d'arte per la casa. Moduli asimmetrici rivestiti da maglie e tessuti negli iconici grafismi in diversi materiali come lane pregiate, fili di lame, fili fiammati, sono assemblati con otto tessere come un prezioso mosaico, su di grande struttura in mdf laccata.

The unique Missoni patchwork becomes an art object for the home. Asymmetric modules covered with iconic knits and fabrics in different materials such as precious wools, lame threads, flame threads, are assembled like mosaic tiles on a large lacquered mdf structure.

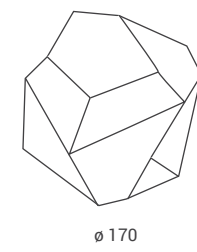

Ø 170

ARTWORK "8"

ARTWORK ARTWORK

design by
MISSONI STUDIO
Made in Italy

Materiali - Materials

Struttura: MDF laccato a liquido

Rivestimento: selezione di tessuti non sfoderabili lavabili a secco secondo le indicazioni di ciascun tessuto



INDOOR

Structure: *MDF liquid coated*

Upholstery: *non-removable fabric, dry washable according to the fabric specifications*

Peso netto	<i>Net weight</i>	24 kg
Peso con imballo	<i>Packed weight</i>	50 kg
Volume imballo	<i>Packed volume</i>	0,8 m³
Portata massima	<i>Maximum load</i>	0 kg

ARTWORK "16"

ARTWORK ARTWORK

1B4M000119



L'inconfondibile patchwork Missoni diventa oggetto d'arte per la casa. L'art work e' composta da una struttura in PLA stampato 3D. Un piccolo gioiello composto da sedici tessere tridimensionali in vari tessuti e grafiche tipiche della Maison e rifinito con una cornice di metallo. Come sfaccettature di una pietra preziosa, i moduli utilizzati in tessere rivestite di tessuto non sfoderabile ne esaltano la dinamicità.

The exclusive Missoni patchwork becomes an art object for the home. The artwork is composed of a 3D printed PLA structure. A small jewel composed of three-dimensional tiles in various fabrics and typical graphics of the Maison and framed by metal finishing. Like facets of a precious stone, the modules used in tiles covered with non-removable fabric enhance its dynamism

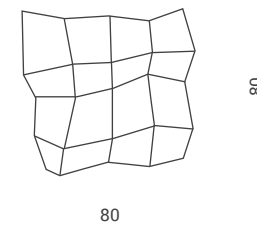

ARTWORK "16"

ARTWORK ARTWORK

design by
MISSONI STUDIO
Made in Italy

Materiali - Materials

Struttura: PLA stampato in 3D e cornice in metallo verniciato a liquido

Rivestimento: selezione di tessuti non sfoderabili lavabili a secco secondo le indicazioni di ciascun tessuto



INDOOR

*Structure: 3D printed PLA and liquid coated metal frame
Upholstery: non-removable fabric, dry washable according to the fabric specifications*

Peso netto	<i>Net weight</i>	15 kg
Peso con imballo	<i>Packed weight</i>	20 kg
Volume imballo	<i>Packed volume</i>	0,5 m³
Portata massima	<i>Maximum load</i>	0 kg

PANETTONE

POUF POUF

- 1C4M000019 - SCIA
- 1A4M000019 - ATACAMA OUTDOOR
- 1C4M000010 - NASTRI
- 1C4M000018 - ZAMBIA



Icona del quotidiano, il design urbano metropolitano diventa un elemento di arredo. Il pouf creato in poliuretano espanso indeformabile avvolge una struttura interna in legno che lo rende compatto e robusto. Il Panettone è realizzato in tessuto non sfoderabile, selezionabile dalla Collezione Missoni Home. Disponibile in un'unica dimensione adatta a tutti gli spazi.

Icon of everyday life, urban hub design becomes a piece of furniture. The pouf created in non-deformable polyurethane foam envelops an internal wooden structure which makes it compact and robust. The Panettone is made of non-removable fabric, selectable from the Missoni Home Collection. Available in a single size suitable for all spaces.

1C4M000019 - SCIA



153



156



174



601

1A4M000019- ATACAMA OUTDOOR



221

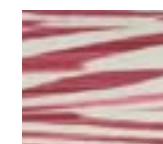

571



501

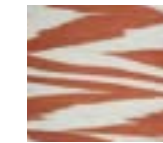

591

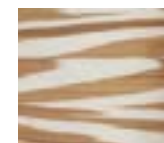

621

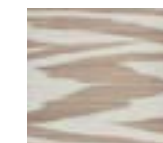

721



601

PANETTONE

POUF POUF

design by
MISSONI STUDIO
Made in Italy

Materiali - Materials

Struttura: legno multistrato con poliuretano espanso indeformabile

Rivestimento: tessuto non sfoderabile, lavabile secondo le indicazioni riportate sull'etichetta



Structure: hardwood plywood with open-cell polyurethane
Upholstery: non-removable fabric, dry washable according to the fabric specifications

1C4M000010- NASTRI



591



531



251



651



501



601

1C4M000018- ZAMBIA



211

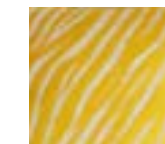

531



621



641



651

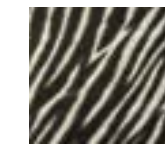

601

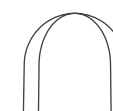
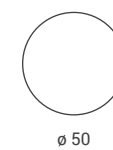

Peso netto	<i>Net weight</i>	7,5 kg
Peso con imballo	<i>Packed weight</i>	10 kg
Volume imballo	<i>Packed volume</i>	0,1 m³
Portata massima	<i>Maximum load</i>	100 kg

CIAMBELLA

POUF POUF

- 1C4M000023 - LAMB OUTDOOR
- 1C4M000027 - ZAMBIA
- 1C4M000026 - NASTRI
- 1A4M000020 - ANDE
- 1C4M000029 - SCIA



Divertente imbottito pouf a forma di ciambella. L'allegorica struttura in poliuretano espanso indeformabile avvolge una struttura interna in legno che la rende compatta e robusta. Il pouf è rivestito in tessuto non sfoderabile, selezionabile dalla Collezione Missoni Home. L'elegante e moderno design della forma conviviale è facile da movimentare ed eclettico in ogni ambiente.

Funny padded donut-shaped pouffe. The allegorical structure in non-deformable polyurethane foam envelops an internal wooden structure which makes it compact and robust. The pouf is covered in non-removable fabric, selectable from the Missoni Home Collection. The elegant and modern design of the convivial shape is easy to move and eclectic in any environment

1C4M000023 - LAMB OUTDOOR



20

53



50

59

1C4M000027 - ZAMBIA

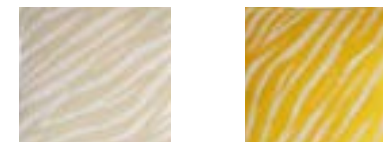

211

531



621

641

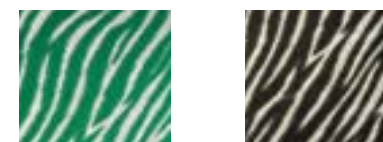

651

601

1C4M000029 - SCIA



174

156

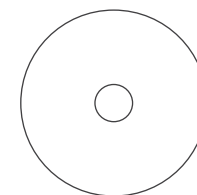

Ø 130



50

CIAMBELLA

POUF POUF

design by
MISSONI STUDIO
Made in Italy

Materiali - Materials

Struttura: legno multistrato con poliuretano espanso indeformabile

Rivestimento: tessuto non sfoderabile, lavabile secondo le indicazioni riportate sull'etichetta



INDOOR

Structure: hardwood plywood with open-cell polyurethane

Upholstery: non-removable fabric, dry washable according to the fabric specifications

1C4M000026 - NASTRI



591

531

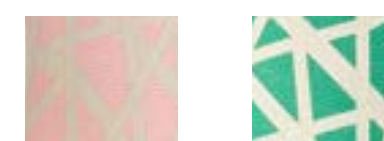

251

651



501

601

1A4M000020 - ANDE

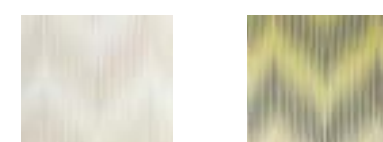

211

153

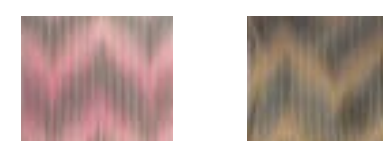

157

162

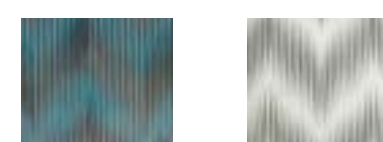

174

601

Peso netto	<i>Net weight</i>	37 kg
Peso con imballo	<i>Packed weight</i>	42 kg
Volume imballo	<i>Packed volume</i>	0,8 m³
Portata massima	<i>Maximum load</i>	100 kg

SPIDER

TAVOLINO LOW TABLE

TAVOLINO ROT. Ø70xH30: 1C4M000002
 TAVOLINO ROT. Ø50xH50: 1C4M000003
 TAVOLINO ELLITTICO 160x54xH30: 1C4M000008

SPIDER

TAVOLINO LOW TABLE

design by
MISSONI STUDIO
 Made in Italy



Materiali - Materials

Struttura: telaio in acciaio verniciato a polvere
 Piano: disco in vetro temprato accoppiato con resine epossidiche BIO, lavorate interamente a mano

Base: powder coated steel
 Table top: tempered glass handmade covered with BIO epoxy resin



Nuovo set di coffee table in resina. I tavolini dal piano tondo in resina colata su vetro sono interamente lavorati a mano con astratti grafismi che creano aree di colore intenso dalla forte personalità. I dischi poggiano su strutture geometriche in acciaio verniciato in diverse varianti colore e dimensioni.

New resin coffee table set. The tables with a round top in resin cast on glass are entirely handmade with abstract graphics that create areas of intense color with a strong personality. The discs rest on geometric sculptural structures in painted steel in different colors and sizes.

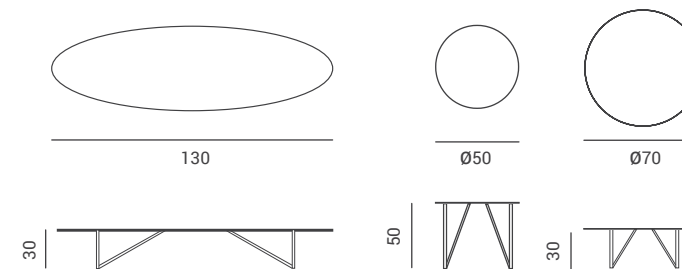

Versione da Ø 50 cm	<i>Version Ø 50 cm</i>	
Peso netto	<i>Net weight</i>	15 kg
Peso con imballo	<i>Packed weight</i>	20 kg
Volume imballo	<i>Packed volume</i>	0,2 m³
Versione da Ø 70 cm	<i>Version Ø 70 cm</i>	
Peso netto	<i>Net weight</i>	10 kg
Peso con imballo	<i>Packed weight</i>	15 kg
Volume imballo	<i>Packed volume</i>	0,3 m³
Versione H 30 cm	<i>Version H 30 cm</i>	
Peso netto	<i>Net weight</i>	20 kg
Peso con imballo	<i>Packed weight</i>	25 kg
Volume imballo	<i>Packed volume</i>	0,4 m³

GRAVITÀ

POLTRONA E DIVANO ARMCHAIR AND SOFA

POLTRONA: 1L4M000902
 DIVANO 2 POSTI: 1L4M000903
 DIVANO 3 POSTI: 1L4M000904



Dettaglio Detail

GRAVITÀ

POLTRONA E DIVANO ARMCHAIR AND SOFA

design by
BENDIK TORVIN
 Made in Italy

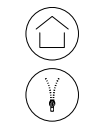

INDOOR



RIVESTIMENTO SFODERABILE
 REMOVABLE COVER

Materiali - Materials

Struttura: legno multistrato, sospensione su cinghie elastiche

Piedini: plastica antiscivolo e antigraffio

Imbottitura: poliuretano espanso indeformabile a quote differenziate, rivestito di ovatta in fibra di poliestere

Rivestimento: tessuto sfoderabile, lavabile secondo le indicazioni riportate sull'etichetta

Structure: plywood, elastic webbing suspension

Feet: anti-slip and non-scratch plastic

Padding: non-deformable polyurethane foam with different densities, covered with polyester fiber wadding

Upholstery: removable fabric, washable according to the instructions on the label

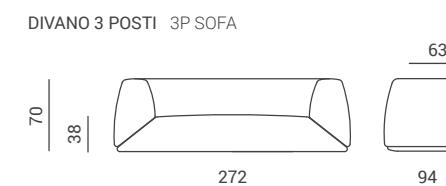
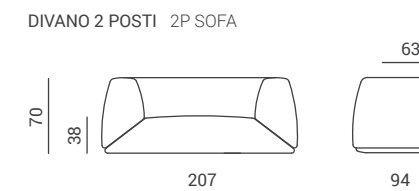
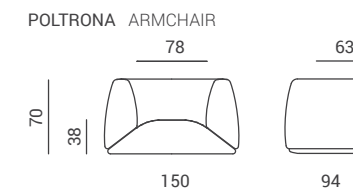

Sedute a sistema. Progetto uniforme, pluriforme, policromo. Il comfort essenziale e la rotondità lineare sono la caratteristica delle sedute Gravità. L'estrema funzionalità della struttura imbottita consente sviluppi in 3 dimensioni, dalla poltrona al divano 3 posti. Il rivestimento: a scelta tra i tessuti d'arredamento Missoni Home Collection, può allineare o essere fattore distintivo.

Seating range. A uniform design, multiform and polychrome. The hallmarks of the Gravità collection are essential comfort and a linear roundness. The great functionality of the padded structure allows for the development of the range in 3 sizes, from the armchair to a 3-seat sofa. The upholstery can be chosen from furnishing fabrics in the Missoni Home Collection, to be a distinctive factor or to align.

Poltrona	Chair		Divano 3 posti	Sofa 3 seat	
Peso netto	Net weight	34 kg	Peso netto	Net weight	54 kg
Peso con imballo	Packed weight	40 kg	Peso con imballo	Packed weight	60 kg
Volume imballo	Packed volume	1,5 m ³	Volume imballo	Packed volume	2,8 m ³
Portata massima	Maximum load	120 kg	Portata massima	Maximum load	300 kg
Divano 2 posti	Sofa 2 seat				
Peso netto	Net weight	44 kg			
Peso con imballo	Packed weight	50 kg			
Volume imballo	Packed volume	2,15 m ³			
Portata massima	Maximum load	240 kg			

MAMA SOFT

POLTRONA, POGGIPIEDI, DIVANO, POUF ARMCHAIR, FOOTREST, SOFA, POUF

POLTRONA MEDIA: 1B4M000107
 POGGIPIEDI POLTRONA MEDIO: 1B4M000108
 POUF MEDIO: 1B4M000111
 DIVANO MEDIO: 1B4M000109
 POGGIPIEDI DIVANO MEDIO: 1B4M000110
 POLTRONA GRANDE: 1B4M000112
 POGGIPIEDI POLTRONA GRANDE: 1B4M000113
 POUF GRANDE: 1B4M000109
 DIVANO GRANDE: 1B4M000114
 POGGIPIEDI DIVANO GRANDE: 1B4M000115



Divano Morbido e confortevole declinato in diverse tipologie. Il sofà è rivestito in tessuto sfoderabile e selezionabile dalla Collezione Missoni Home. L'imbottitura in microsferine di polipropilene, offre una compattezza invitante e graduata. La morbida ed avvolgente seduta regala un sostegno confortevole. La serie Mama soft è composta da poltrone e poggiatesta di varie dimensioni facili da movimentare per creare accoglienti isole relax.

Soft sofa upholstered in removable fabric selectable from the Missoni Home Collection. The padding in polypropylene microspheres offers an inviting and graduated compactness. The soft and enveloping seat give a comfortable support. The Mama soft series is made up of footrest and armchairs of various sizes that are easy to move to create welcoming relaxation islands.

POLTRONA MEDIA MEDIUM ARMCHAIR

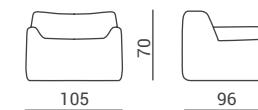

POGGIPIEDI POLTRONA ARMCHAIR FOOTREST

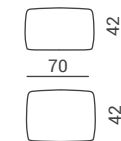

POUF MEDIO MEDIUM POUF

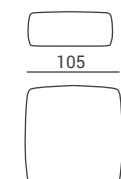

DIVANO MEDIO MEDIUM SOFA

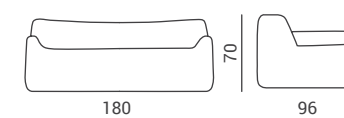

POGGIPIEDI DIVANO SOFA FOOTREST

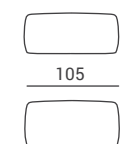

POLTRONA GRANDE BIG ARMCHAIR

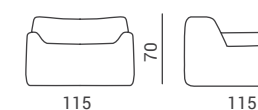

POGGIPIEDI POLTRONA ARMCHAIR FOOTREST

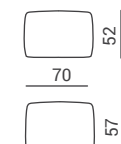

POUF GRANDE BIG POUF

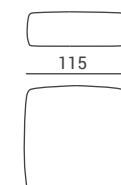

DIVANO GRANDE BIG SOFA

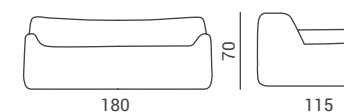

POGGIPIEDI DIVANO SOFA FOOTREST

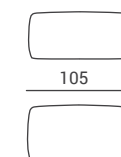

MAMA SOFT

POLTRONA, POGGIPIEDI, DIVANO, POUF ARMCHAIR, FOOTREST, SOFA, POUF

design by
BENDIK TORVIN
 Made in Italy



OUTDOOR



RIVESTIMENTO SFODERABILE
 REMOVABLE COVER

Materiali - Materials

Struttura: microsferine di polipropilene e fibra di poliestere

Rivestimento: sfoderabile con fondo in tessuto idrorepellente e antimacchia

Structure: polypropylene microbeads and polyester fiber

Cover: removable, bottom in water repellent and stain proof fabric



MISURA MEDIA / MEDIUM SIZE

Poltrona	Armchair	
Peso netto	Net weight	13,5 kg
Peso con imballo	Packed weight	17 kg
Volume imballo	Packed volume	0,7 m ³
Portata massima	Maximum load	100 kg

Poggiatesta poltrona	Armchair Footrest	
Peso netto	Net weight	4 kg
Peso con imballo	Packed weight	6 kg
Volume imballo	Packed volume	0,1 m ³
Portata massima	Maximum load	100 kg

Pouf	Pouf	
Peso netto	Net weight	9,5 kg
Peso con imballo	Packed weight	12,5 kg
Volume imballo	Packed volume	0,5 m ³
Portata massima	Maximum load	100 kg

Divano	Sofa	
Peso netto	Net weight	19,5 kg
Peso con imballo	Packed weight	25,5 kg
Volume imballo	Packed volume	1,2 m ³
Portata massima	Maximum load	100 kg

Poggiatesta divano	Sofa Footrest	
Peso netto	Net weight	6 kg
Peso con imballo	Packed weight	8 kg
Volume imballo	Packed volume	0,2 m ³
Portata massima	Maximum load	100 kg

MISURA GRANDE / BIG SIZE

Poltrona	Armchair	
Peso netto	Net weight	16,5 kg
Peso con imballo	Packed weight	20 kg
Volume imballo	Packed volume	0,9 m ³
Portata massima	Maximum load	100 kg

Poggiatesta poltrona	Armchair Footrest	
Peso netto	Net weight	5 kg
Peso con imballo	Packed weight	7 kg
Volume imballo	Packed volume	0,1 m ³
Portata massima	Maximum load	100 kg

Pouf	Pouf	
Peso netto	Net weight	12 kg
Peso con imballo	Packed weight	15 kg
Volume imballo	Packed volume	0,6 m ³
Portata massima	Maximum load	100 kg

Divano	Sofa	
Peso netto	Net weight	16 kg
Peso con imballo	Packed weight	22 kg
Volume imballo	Packed volume	1,4 m ³
Portata massima	Maximum load	100 kg

Poggiatesta divano	Sofa Footrest	
Peso netto	Net weight	7 kg
Peso con imballo	Packed weight	9 kg
Volume imballo	Packed volume	0,3 m ³
Portata massima	Maximum load	100 kg

INNTIL

DIVANO MODULARE MODULAR SOFA

ANGOLARE: 1K4M000106
 CHAISE LONGUE DX: 1K4M000100
 CHAISE LONGUE SX: 1K4M000101
 FINALE 2 POSTI DX: 1K4M000102
 FINALE 2 POSTI SX: 1K4M000103
 FINALE 3 POSTI DX: 1K4M000104
 FINALE 3 POSTI SX: 1K4M000105



Seduta modulare. La struttura del divano 3 posti indeformabile, di linea snella, ha un design allungato e funzionale, e può anche includere un modulo isola. Il comfort dello schienale è raddoppiato dal lungo cuscino imbottito inserito a incastro. I moduli sono agganciati fra loro. Il rivestimento d'assie-

Modular seating. The structure of this non-deformable 3-seater modular element, with a slender line, has an elongated and functional design and can also be combined with a chaise longue. The comfort is doubled by the inclusion of a long back cushion. Each module can be hooked together and the upholstery chosen from furnishing fabrics in the Missoni Home Collection.

ELEMENTO ANGOLARE ANGULAR MODULE

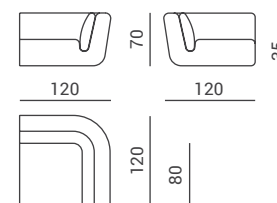

CHAISE LOUNGE DESTRO O SINISTRO CHAISE LOUNGE RIGHT OR LEFT

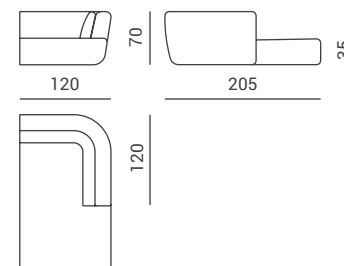

ELEMENTO 2 POSTI DESTRO O SINISTRO 2P MODULE RIGHT OR LEFT

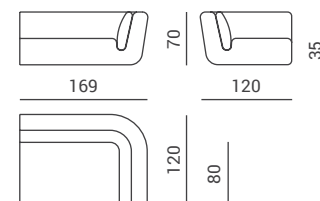

ELEMENTO 3 POSTI DESTRO O SINISTRO 3P MODULE RIGHT OR LEFT

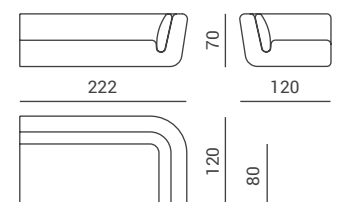

INNTIL

POLTRONA E DIVANO MODULARE ARMCHAIR AND MODULAR SOFA

design by
BENDIK TORVIN
 Made in Italy



INDOOR



RIVESTIMENTO SFODERABILE
 REMOVABLE COVER

Materiali - Materials

Struttura: legno multistrato, sospensione su cinghie elastiche

Piedini: plastica antiscivolo e antigraffio

Imbottitura: poliuretano espanso indeformabile a quote differenziate, rivestito di ovatta in fibra di poliestere

Rivestimento: tessuto sfoderabile, lavabile secondo le indicazioni riportate sull'etichetta

Sistema di aggancio moduli: ad aggancio rapido

Structure: plywood, elastic webbing suspension

Feet: non-slip and non-scratch plastic

Padding: non-deformable polyurethane foam in different densities, covered with polyester fiber wadding

Upholstery: removable fabric, washable according to the instructions on label

Hooking system to link modules: quick interlocking



Elemento angolare
Peso netto
Peso con imballo
Volume imballo
Portata massima

Element - corner
Net weight
Packed weight
Packed volume
Maximum load

50 kg
60 kg
1,35 m³
120 kg

Elemento 2 posti
Peso netto
Peso con imballo
Volume imballo
Portata massima

Element - 2 seat
Net weight
Packed weight
Packed volume
Maximum load

70 kg
80 kg
1,9 m³
240 kg

Chaise longue
Peso netto
Peso con imballo
Volume imballo
Portata massima

Chaise longue
Net weight
Packed weight
Packed volume
Maximum load

67 kg
77 kg
2,2 m³
240 kg

Elemento 3 posti
Peso netto
Peso con imballo
Volume imballo
Portata massima

Element - 3 seat
Net weight
Packed weight
Packed volume
Maximum load

80 kg
90 kg
2,4 m³
300 kg

TEKTONIK

DIVANO MODULARE MODULAR SOFA

CUSCINO: 1V4M000106
 POUF: 1V4M000101
 BRACCIOLO: 1V4M000100
 SCHIENALE: 1V4M000103
 SEDUTA GRANDE: 1V4M000105
 SEDUTA PICCOLA: 1V4M000104

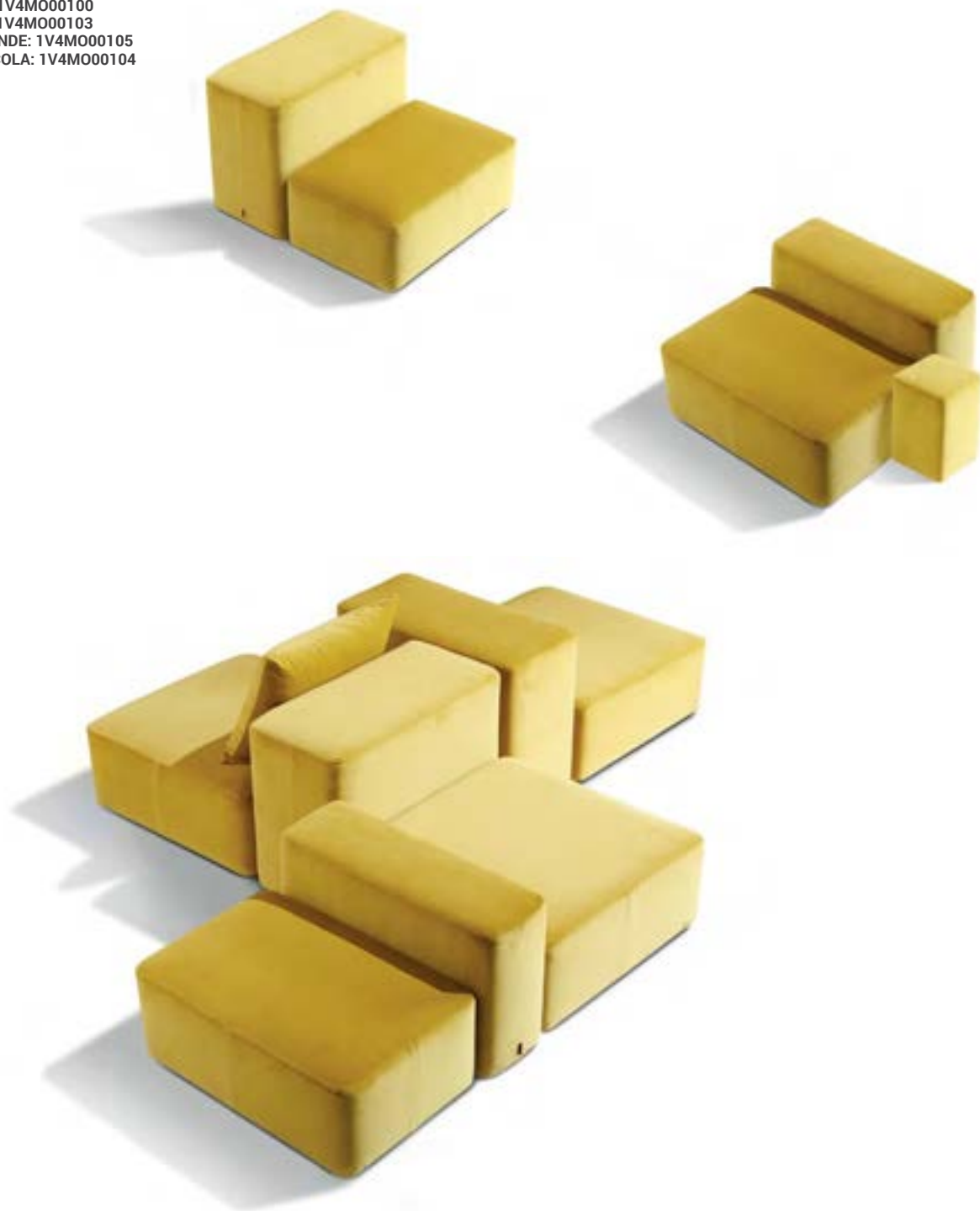

Semplice, composto. Sistema personalizzabile di sedute indipendenti, accostabili e bloccate da barre antisdrucchiolo. I moduli solidi e scultorei consentono un gioco di alternanze e geometrie valorizzato dalla disposizione e dal rivestimento. Tessuti d'arredamento a scelta di Missoni Home Collection. Suggesta l'aggiunta di un cuscino poggiareni per ogni seduta.

Simple, composed. This customisable system of independent seat modules are joined and locked by anti-slip bars. The solid and sculptural modules allow a play of different compositions and geometries and enhanced by the choice of Upholstery: to be chosen from furnishing fabrics in the Missoni Home Collection. The addition of back cushion is recommended for each seat module.

CUSCINO POGGIARENI BACK CUSHION

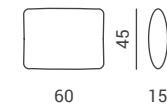

POUF

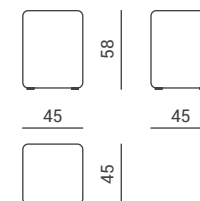

BRACCIOLO ARMREST

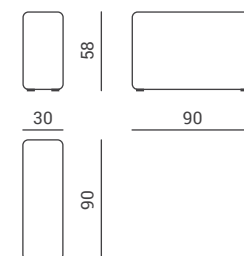

SCHIENALE BACK

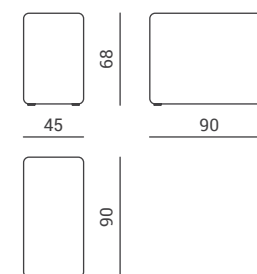

SEDUTA PICCOLA SMALL SEAT

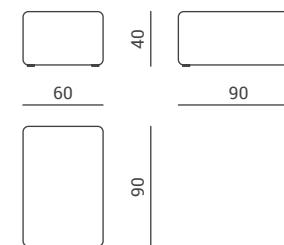

SEDUTA GRANDE LARGE SEAT

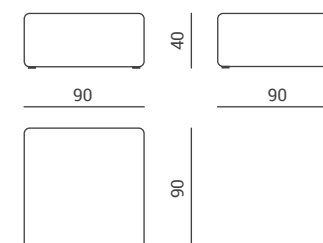

TEKTONIK

DIVANO MODULARE MODULAR SOFA

design by
BENDIK TORVIN
 Made in Italy



INDOOR



RIVESTIMENTO SFODERABILE
 REMOVABLE COVER

Materiali - Materials

Struttura: legno multistrato con sospensione su cinghie elastiche

Imbottitura: poliuretano espanso indeformabile a quote differenziate, rivestito di ovatta in fibra di poliestere

Rivestimento: tessuto sfoderabile, lavabile secondo le indicazioni riportate sull'etichetta

Sistema di aggancio fra moduli: barre antiscivolo in appoggio

Piedini: gomma morbida antiscivolo e antigraffio

Structure: multilayer with elastic wadding suspension

Padding: non-deformable polyurethane foam in different densities, covered with polyester fiber wadding

Upholstery: removable fabric, washable according to the instructions on the label

Coupling system between modules: non-slip support bars

Feet: non-slip and non-scratch soft rubber

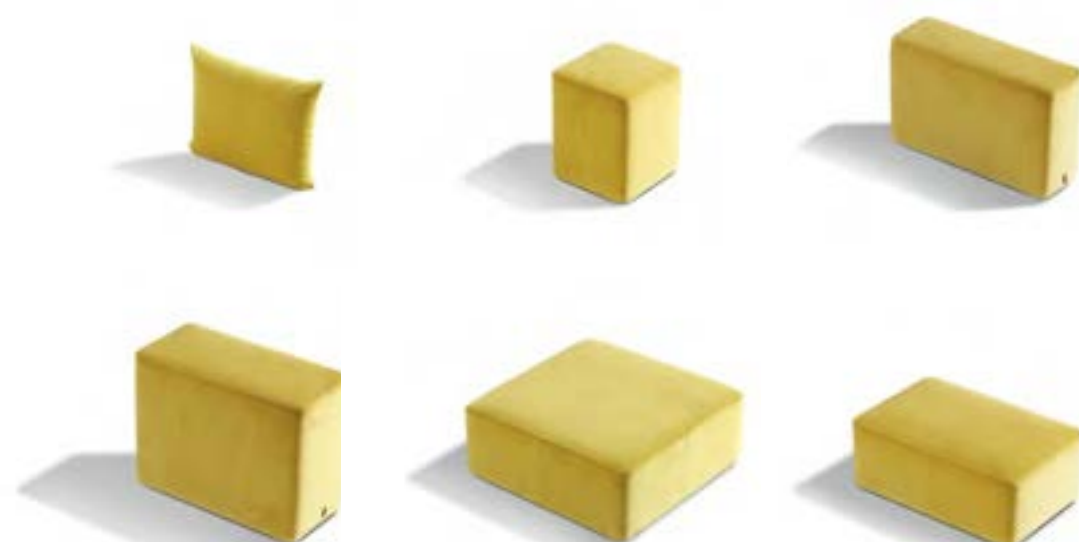

Modulo Unit	Peso netto Net weight	Peso con imballo Packed weight	Volume imballo Packed volume
Cuscino poggiareni Back cushion	1 kg	1 kg	0,04 m ³
Pouf Pouf	12,5 kg	14,5 kg	0,15 m ³
Bracciolo Arm	16,5 kg	18,5 kg	0,2 m ³
Schienale Back	23 kg	25 kg	0,25 m ³
Seduta grande Large seat	20 kg	23 kg	0,4 m ³
Seduta piccola Small seat	14 kg	16 kg	0,25 m ³
Portata massima per modulo Maximum load per module		120 kg	

CORDULA

POLTRONA ROTONDA ROUND CHAIR

1K4M00080

Altri prodotti della collezione Cordula:
pag. 34

Other products from Cordula collection:
pag. 34



Dettaglio Detail

CORDULA

POLTRONA ROTONDA ROUND CHAIR

design by
MISSONI STUDIO
Made in Italy

Materiali - Materials

Struttura: tondino in acciaio inox curvato a mano, finitura spazzolata

Rivestimento: corda in PET HT a motivo chevron multicolor

Piedini: in gomma antiscivolo e antigraffio

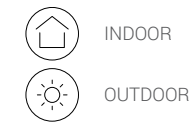

Structure: hand-curved stainless steel rod, brushed finish
Covering: PET HT rope with multicolour chevron motif
Feet: non-slip and non-scratch rubber



Essenziale, funzionale, ariosa. La poltrona ellittica prende forma da 3 anelli di acciaio incurvato sovrapposti e intelaiati da corde a micro-zigzag multicolor appositamente progettate e annodate a mano. La struttura design robusta e il materiale impermeabile rendono la seduta ubiqua, da interni e da esterni.

Essential, functional, airy. This elliptical armchair takes shape from 3 overlapping curved steel rings and framed by hand-knotted multicolour micro-zigzag rope. The sturdy design structure and waterproof material make the chair ideal for indoor and outdoor.

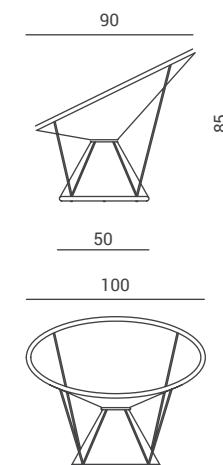

Peso netto	Net weight	10 kg
Peso con imballo	Packed weight	14 kg
Volume imballo	Packed volume	0,87 m ³
Portata massima	Maximum load	100 kg

GRANDMA

POLTRONA ARMCHAIR

LIGHT: 1W4MO00010
DARK: 1W4MO00011



LIGHT



DARK

GRANDMA

POLTRONA ARMCHAIR

design by
MISSONI STUDIO
Made in Italy

Materiali - Materials

Struttura: legno multistrato / legno massello di rovere o noce americana

Braccioli, legno massello di rovere o noce americana

Imbottitura: poliuretano espanso indeformabile, rivestito di ovatta in fibra di poliestere

Rivestimento: tessuto sfoderabile, lavabile secondo le indicazioni riportate sull'etichetta

Piedini: in lana ad alta densità, antiscivolo e antigraffio



INDOOR



RIVESTIMENTO SFODERABILE
REMOVABLE COVER

Structure: plywood / solid oak or American walnut

Armrests, solid oak or American walnut

Padding: non-deformable polyurethane foam covered with polyester fiber wadding

Upholstery: removable fabric, washable according to the instructions on the label

Feet: anti-slip and non-scratch high-density wool



Classico moderno. La confortevole poltrona decorativa di forma squadrata si appoggia a braccioli incurvati in legno massello (finitura rovere o noce americana). Il pattern del rivestimento materico è a scelta tra i tessuti d'arredamento Missoni Home Collection.

A modern classic. The comfortable square-shaped decorative armchair rests on curved solid wood armrests (oak or american walnut finish). Furnishing fabrics from the Missoni Home Collection can be chosen for the upholstery.

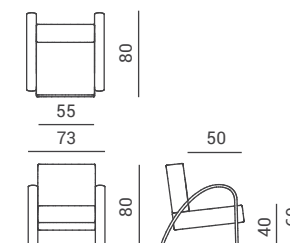

Poltrona	Armchair	
Peso netto	Net weight	14 kg
Peso con imballo	Packed weight	20 kg
Volume imballo	Packed volume	0,5 m³
Portata massima	Maximum load	100 kg

MILADY

POLTRONA ARMCHAIR

1W4M00001

MILADY

POLTRONA ARMCHAIR

design by
MISSONI STUDIO
Made in Italy



INDOOR

Materiali - Materials

Struttura: legno multistrato, sospensione su cinghie elastiche

Imbottitura: poliuretano espanso indeformabile e fibra poliestere

Piedini: lana ad alta densità

Rivestimento sedile e schienale: tessuto sfoderabile, lavabile secondo le indicazioni riportate sull'etichetta

Rivestimento gambe: tessuto non sfoderabile, lavabile con un panno umido

Structure: plywood, elastic wadding suspension

Feet: high density wool

Padding: non-deformable polyurethane foam in different densities, covered with polyester fiber wadding

Upholstery: non-removable fabric, washable with a damp cloth



Profilo e forma. Come un guscio confortevole, la poltrona ha una silhouette insolita e avvolgente dove risalta il tessuto. La struttura scultorea in legno è imbottita in poliuretano espanso a quote e fibra di poliestere. Il rivestimento posizionato ad arte, è a scelta tra le proposte Missoni Home Collection.

Profile and form. Like a comfortable shell, the armchair has an unusual and enveloping silhouette with a focus on the fabric. The sculptural wood structure is padded with polyurethane foam and polyester fiber. Artfully positioned, the upholstery can be chosen from furnishing fabrics in the Missoni Home Collection.

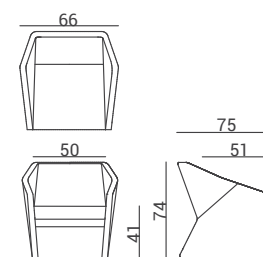

Poltrona	Chair	
Peso netto	Net weight	22 kg
Peso con imballo	Packed weight	26 kg
Volume imballo	Packed volume	0,45 m³
Portata massima	Maximum load	120 kg

ART GLASS

TAVOLINO LOW TABLE

Ø50: 1A4M000004
 Ø65: 1A4M000005
 Ø90: 1A4M000006



Luminosità e tecnica artigiana. I suggestivi tavolini in resina su vetro sono frutto di tecniche artigiane. Il piano tondo e sfavillante alterna mix di sfumature infuocate, blu cielo e dark. L'effetto scenografico è dato da resine pigmentate colate in vari strati sopra il vetro. La movimentazione manuale della materia crea un pattern decorativo di alto valore estetico e profonda luminosità. Lucidatura a mano. Poggia su struttura in metallo con gambe ad ellisse. 3 dimensioni e 3 set di colorazioni.

Luminosity with artisan technique. The evocative resin on glass coffee tables are the result of artisan techniques. The round gleaming top alternates a mix of fiery shades, sky blue and dark. A scenographic effect is achieved by pigmented resins cast in various layers over the glass. The material is handled manually and this results in a decorative pattern of high aesthetic value and deep luminosity. Polished by hand, it rests on a metal structure with ellipse profile legs. Available in 3 sizes and 3 set of colours.



GRIGIO 132

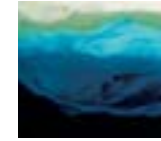

BLU 150



ROSSO 156

ART GLASS

TAVOLINO LOW TABLE

design by
 MISSONI STUDIO
 Made in Italy

Materiali - Materials

Struttura: telaio in acciaio a sezione ellittica
 Piano d'appoggio: disco in vetro temprato accoppiato con resine, lavorate interamente a mano
 Piedini: in lana ad alta densità, antiscivolo e antigraffio



INDOOR

*Structure: steel elliptical frame
 Top: tempered glass paired with hand crafted resin works
 Feet: anti-slip and non-scratch high-density wool*

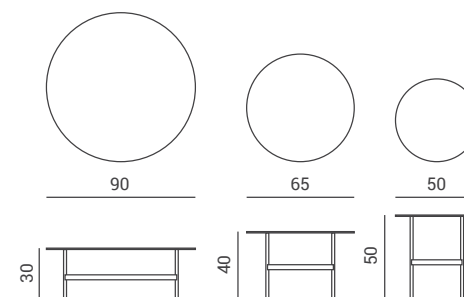

Versione da Ø 90 cm
Peso netto 13 kg
Peso con imballo 13 kg
Volume imballo 0,3 m³

Version Ø 90 cm
Net weight
Packed weight
Packed volume

Versione da Ø 50 cm
Peso netto 5 kg
Peso con imballo 7 kg
Volume imballo 0,2 m³

Version Ø 50 cm
Net weight
Packed weight
Packed volume

Versione da Ø 65 cm
Peso netto 7 kg
Peso con imballo 9 kg
Volume imballo 0,2 m³

Version Ø 65 cm
Net weight
Packed weight
Packed volume

CORDULA

TAVOLINO ROTONDO LOW ROUND TABLE

1C4M000032



Dettaglio Detail

CORDULA

TAVOLINO ROTONDO LOW ROUND TABLE

design by
MISSONI STUDIO
Made in Italy

Materiali - Materials

Struttura: tondino in acciaio inox curvato, finitura spazzolata, verniciata in abbinamento alla corda
Rivestimento: corda in PET HT a motivo chevron multicolor
Piano d'appoggio: vetro extra chiaro
Piedini: in gomma antiscivolo e antigraffio

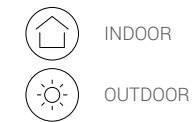

Structure: curved stainless steel rod, brushed finish, painted in combination with the cord colour
Covering: PET HT rope with multicolour chevron motif
Table top: extra clear glass
Feet: non-slip and non-scratch rubber

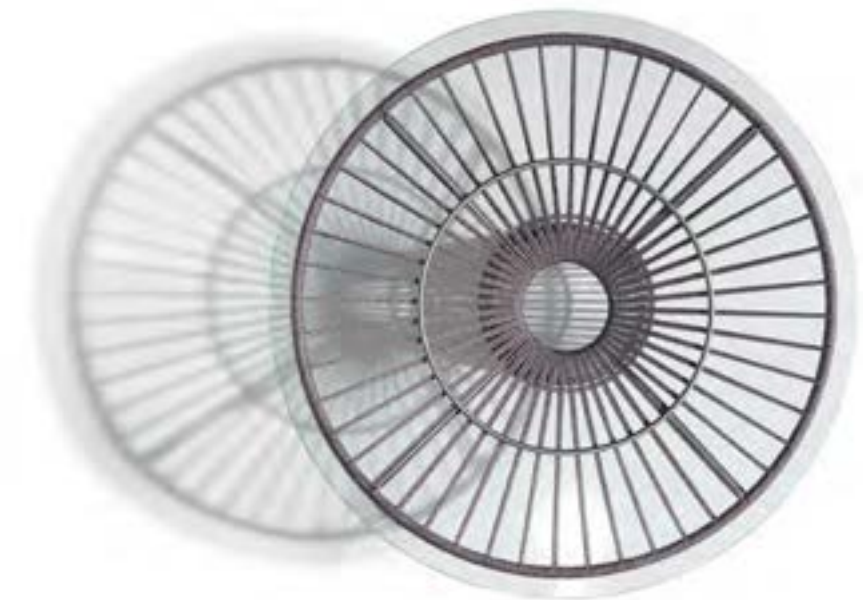

Corda e cristallo. L'elegante tavolo design in dimensione coffee table ha struttura in acciaio curvato ad anelli sovrapposti e base conica. Corde a micro-zigzag multicolor annodate a mano crea il prezioso intreccio a raggiera che traspare dal piano in cristallo.

Rope and glass. The elegant design of this coffee table has a curved steel Structure: made from overlapping rings and a conical base. Hand-knotted multicolour micro-zigzag rope creates a precious radial weave that can be viewed through the glass top.

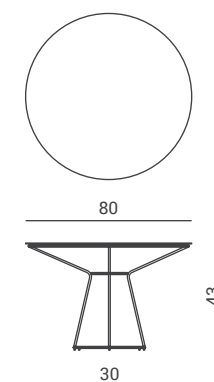

Peso netto	Net weight	16 kg
Peso con imballo	Packed weight	20 kg
Volume imballo	Packed volume	0,55 m ³

GEMMA

POUF POUF

1W4LV00100



Design essenziale, easy. Il pouf a mezzo cono con la linea pulita e scultorea di un solido ha una seduta confortevole e indeformabile. Da sottolineare la sua stabilità ottimizzata dal sostegno laccato che sorregge e delinea la base. Il rivestimento è a scelta tra le proposte Missoni Home Collection.

Essential, easy design. The half-cone pouf, with the clean and sculptural line of a solid block, has a comfortable and non-deformable seat. The lacquered plinth optimises its stability and emphasises the solidity of the base. The pouf can be upholstered with any suitable furnishing fabric of the Missoni Home Collection.

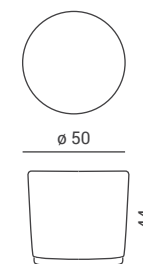

GEMMA

POUF POUF

design by
MISSONI STUDIO
Made in Italy

Materiali - Materials

Base: fibra di legno, finitura laccata
Imbottitura: poliuretano espanso indeformabile, rivestito di ovatta in fibra di poliestere
Piedini: lana ad alta densità
Rivestimento: tessuto sfoderabile, lavabile secondo le indicazioni riportate sull'etichetta



INDOOR



RIVESTIMENTO SFODERABILE
REMOVABLE COVER

Base: wooden fiber, lacquered finish
Padding: non-deformable polyurethane foam covered with polyester fiber wadding
Feet: high-density wool
Upholstery: removable fabric, washable according to the instructions on the label



Peso netto	<i>Net weight</i>	10 kg
Peso con imballo	<i>Packed weight</i>	12 kg
Volume imballo	<i>Packed volume</i>	0,125 m³
Portata massima	<i>Maximum load</i>	120 kg

PUNTASPILLONE

POUF POUF

1T4M000100



Decor e relax (shape da relax). Ispirato alla forma del cuscinetto puntaspilli ma di proporzioni giganti, il pouf è l'allegoria macro del tipico elemento sartoriale. È composto da morbidi spicchi imbottiti di gommapiuma e rivestiti artigianalmente con tessuto a scelta della Missoni Home Collection. Rivestimento posizionato ad arte.

Relaxed decoration (a restful shape). Inspired by the shape of a pincushion, but in giant scale, this pouf is the macro allegory of this typical tailoring tool. It is made up of soft padded segments of foam and upholstered by hand with fabric chosen from the Missoni Home Collection. The fabric design will be artfully positioned.

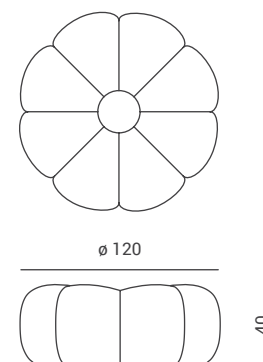

PUNTASPILLONE

POUF POUF

design by
MISSONI STUDIO
Made in Italy



INDOOR

Materiali - Materials

Struttura: legno multistrato

Piedini: lana ad alta densità

Imbottitura: poliuretano espanso indeformabile, rivestito di ovatta in fibra di poliestere

Rivestimento: tessuto non sfoderabile, lavabile con un panno umido

Structure: plywood

Feet: high-density wool

Padding: non-deformable polyurethane foam covered with polyester fiber wadding

Upholstery: non-removable fabric, washable with a damp cloth



Peso netto	Net weight	18 kg
Peso con imballo	Packed weight	20 kg
Volume imballo	Packed volume	0,7 m³
Portata massima	Maximum load	120 kg

DINING
ROOM



FRAMED MIRROR

SPECCHIO MIRROR

130x200: 1S4M000007
 Ø120: 1S4M000010



Decorativo, variabile. La cornice bombata in legno che racchiude e sostiene la superficie specchiante è un suggestivo complemento d'arredo. Il rivestimento nel motivo preferito è da selezionare con tessuto a scelta della Missoni Home Collection. La forma può essere circolare o a rettangolo.

Decorative and versatile. The curved wooden cornice, that encloses and supports the mirror is a charming piece of furniture. The frame can be upholstered in furnishing fabrics from the Missoni Home Collection.

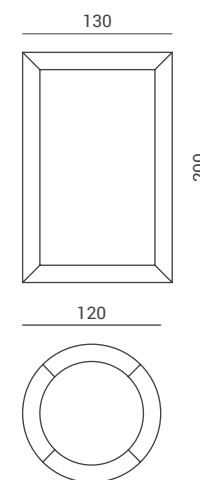

FRAMED MIRROR

SPECCHIO MIRROR

design by
MISSONI STUDIO
 Made in Italy



Materiali - Materials

Struttura: legno massello
 Specchio: vetro antinfortunistico
 Agganci: a scomparsa, utilizzabile in senso verticale o orizzontale
 Rivestimento: tessuto non sfoderabile, lavabile con un panno umido. Pannello posteriore antigraffio

*Structure: solid wood
 Mirror: safety glass
 Hooks: retractable, can be used vertically or horizontally
 Upholstery: non-removable fabric, washable with a damp cloth. Scratch-resistant rear panel*



Versione Version	Peso netto Net weight	Peso con imballo Packed weight	Volume imballo Packed volume
Ø 120	12,5 kg	64,5 kg	0,6 m³
130x200	21 kg	99 kg	0,9 m³

MISS WOOD

TAVOLO TABLE

90X145 1A4M000012
 90X200: 1A4M000011
 90X300: 1A4M000002

Combinabile con: Miss Wood sedia - pag. 46
 Combinable with: Miss Wood chair - pag. 46



Naturale, conviviale. Il tavolo che accompagna la sedia Miss ne mantiene le prerogative tecnico-estetiche. In legno massello, di faggio naturalmente venato, è sostenuto da sinuose e robuste gambe a sezione ellittica. L'innovazione strutturale è nel rapporto tra spessore del piano (di soli 3 cm) e la sua superficie (oltre 2mq). Realizzato con processi altamente tecnologici è, al pari della sedia, rifinito a mano, perfettamente levigato e tinto di sfumature. Disponibile in più dimensioni.

Natural, convivial. The table that accompanies the Miss chair maintains the same technical-aesthetic prerogatives. In natural beech grain solid wood, the top is supported by sinuous and sturdy legs with an elliptical profile. The structural innovation is in the relationship between the thickness of the top (only 3 cm) and the surface (over 2 square meters). Made with highly technological processes it is, like the chair, hand finished, perfectly smoothed and tinted. Available in multiple sizes.

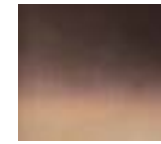

ANTRACITE SFUMATO SHADED 861



ANTRACITE 86

MISS WOOD

TAVOLO TABLE

design by
 FELICE RAGAZZO
 Made in Italy

Materiali - Materials

Struttura: legno massello di faggio lavorato a CNC, con giunzioni organiche. Verniciatura a liquido realizzata a mano con aerografo, in versione tinta unita o sfumata

Oltre i 200 cm di lunghezza, sottostruttura del piano in acciaio, integrata

Piedini: in lana ad alta densità, antiscivolo e antigraffio



INDOOR

Structure: solid beech wood, CNC machined, with biomimetic joints. Liquid painted by hand with airbrush in solid or shaded colour

Over 200 cm length, integrated steel substructure of the table top

Feet: anti-slip and non-scratch high-density wool

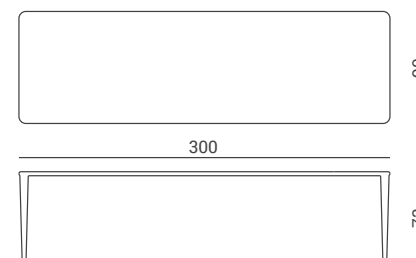
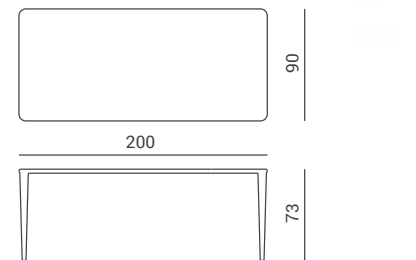
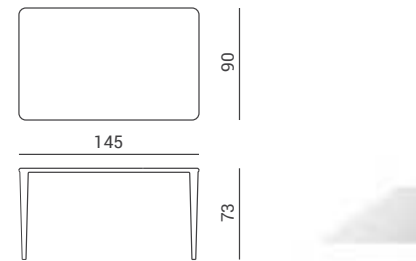

Versione Version	Peso netto Net weight	Peso con imballo Packed weight	Volume imballo Packed volume
145x90	25 kg	35 kg	1,4 m ³
200x90	37 kg	49 kg	1,9 m ³
300x90	65 kg	80 kg	2,8 m ³

MISS WOOD

SEDIA CHAIR

1A4M00003

Combinabile con: Miss Wood tavolo - pag. 44
Versione in tessuto: Miss sedia - pag. 48

Combinable with: Miss Wood table - pag. 44
Fabric version: Miss chair - pag. 48



Sintesi dell'eleganza. La perfezione della tecnica definisce il legno massello, plasmando le geometrie del tessuto. All'agile eleganza della scultura corrisponde una leggerezza robusta, risultato di un profondo studio del rapporto fra equilibrio e resistenza. Prerogativa straordinaria è l'assenza di spigoli nelle giunzioni del corpo, innovazione che conferisce alla struttura la plasticità di una giunzione organica. Realizzata con processi ad alta tecnologia, è rifinita a mano, levigata e dipinta in delicate sfumature.

An elegant synthesis. The perfection of the technique defines the solid wood and shapes the geometries of the material. The agile elegance of the sculpture is matched by a robust lightness and is a result of a profound study of the relationship between balance and resistance. An extraordinary feature is the absence of edges, an innovation that gives the structure the pliancy of an organic joining. Made with high-tech processes, it is finished by hand, smoothed and painted in delicate shades.

MISS WOOD

SEDIA CHAIR

design by
MISSONI STUDIO
Made in Italy

Materiali - Materials

Struttura: legno massello di faggio lavorato a CNC, con giunzioni organiche. Verniciatura a liquido realizzata a mano con aerografo, in versione tinta unita o sfumata

Piedini: in lana ad alta densità, antiscivolo e antigraffio



INDOOR

Structure: solid beech wood, CNC machined, with biomimetic joints. Liquid painted by hand with airbrush in solid or shaded colour

Feet: anti-slip and non-scratch high-density wool



Impilabile Stackable



ARANCIO
SFUMATO
SHADED 591



GIALLO
SFUMATO
SHADED 531



ROSA
SFUMATO
SHADED 251

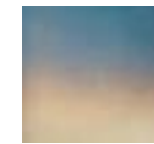

AZZURRO
SFUMATO
SHADED 221



ANTRACITE
SFUMATO
SHADED 861

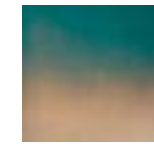

TURCHESE
SFUMATO
SHADED 701



ANTRACITE 86



51

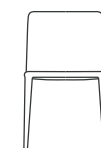

76.5



51



45

Peso netto	Net weight	5,5 kg
Peso con imballo	Packed weight	9 kg
Volume imballo	Packed volume	0,3 m³
Portata massima	Maximum load	120 kg

MISS

SEDIA CHAIR

1T4M000001

Versione in legno: Miss Wood sedia - pag. 46
Altri prodotti della collezione Miss: Miss sgabello - pag. 50
Wooden version: Miss Wood chair - pag. 46
Other products from Miss collection: Miss stool pag. 50



Design ergonomico. Di linea snella e confortevole, la sedia in struttura d'acciaio imbottita in poliuretano espanso e fibra di poliestere, ha rivestimento policromo in tessuto. Il pattern a scelta tra i tessuti d'arredamento Missoni Home Collection. Le gambe esili e rastremate aggiungono eleganza e leggerezza. Vendute a coppie, impilabili.

Ergonomic design. The slender and comfortable line of this chair, with steel structure and padded with polyurethane foam and polyester fiber, can be upholstered in fabrics from the Missoni Home Collection, taking extreme care to position the chosen design to correct effect. The slender, tapered leg gives an elegance and lightness. Stackable and sold in pairs.

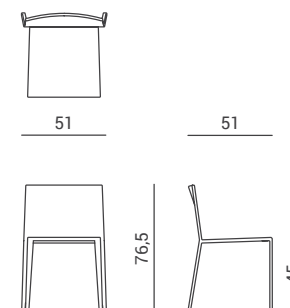

MISS

SEDIA CHAIR

design by
MISSONI STUDIO
Made in Italy

Materiali - Materials

Struttura: acciaio
Imbottitura: poliuretano espanso indeformabile e fibra poliestere
Piedini: gomma morbida antiscivolo e antigraffio
Rivestimento sedile e schienale, tessuto sfoderabile, lavabile secondo le indicazioni riportate sull'etichetta
Rivestimento gambe: tessuto non sfoderabile, lavabile con un panno umido



INDOOR



RIVESTIMENTO SFODERABILE
REMOVABLE COVER

Structure: steel

Padding: non-deformable polyurethane foam and polyester fiber

Feet: non-slip and non-scratch soft rubber

Seat and back Upholstery: removable fabric, washable according to the instructions on the label

Leg cover: non-removable fabric, washable with a damp cloth



Peso netto
Peso con imballo (1 sedia)
Peso con imballo (2 sedie)
Volume imballo
Portata massima

Net weight
Packed weight (1 chair)
Packed weight (2 chairs)
Packed volume
Maximum load

5,5 kg
9 kg
14,5 kg
0,35 m³
120 kg

MISS

SGABELLO STOOL

ALTO: 1T4M00013
NORMALE: 1T4M00014



Impilabile Stackable

MISS

SGABELLO STOOL

design by
MISSONI STUDIO
Made in Italy

Materiali - Materials

Struttura: acciaio
Imbottitura: poliuretano espanso indeformabile e fibra poliestere
Piedini: gomma morbida antiscivolo e antigraffio
Rivestimento sedile e schienale, tessuto sfoderabile, lavabile secondo le indicazioni riportate sull'etichetta
Rivestimento gambe: tessuto non sfoderabile, lavabile con un panno umido
Barra poggia piedi, disponibile nella versione in metallo.



INDOOR



RIVESTIMENTO SFODERABILE
REMOVABLE COVER

Structure: steel
Padding: non-deformable polyurethane foam and polyester fiber
Feet: anti-slip and non-scratch soft rubber
Seat and back Upholstery: removable fabric, washable according to the instructions on the label
Leg cover: non-removable fabric, washable with a damp cloth
Footrest bar, available in metal version.



Impilabile chic. Slanciato e accogliente lo sgabello ha sottile struttura in metallo imbottita in poliuretano espanso e fibra di poliestere. Le gambe rastremate sottolineano l'eleganza della seduta. Il rivestimento a scelta tra i tessuti d'arredamento Missoni Home Collection è posizionato con cura. Sgabelli impilabili, venduti a coppie, disponibili in 2 altezze e con barra poggia piedi in metallo.

Stackable chic. Slender and welcoming, the stool has a thin metal structure and padded with polyurethane and polyester fiber. The tapered legs emphasize the elegance. Upholstery to be chosen from furnishing fabrics in the Missoni Home Collection, with careful attention to the design positioning. Stackable, sold in pairs and available in 2 heights and with metal footrest bar.

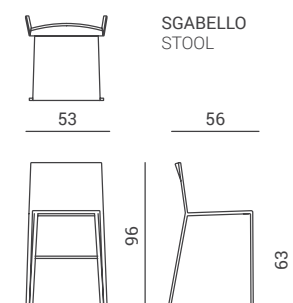

Versione bassa	Version low	
Peso netto	Net weight	7,5 kg
Peso con imballo (1 sedia)	Packed weight (1 chair)	11 kg
Peso con imballo (2 sedie)	Packed weight (2 chairs)	18,5 kg
Volume imballo	Packed volume	0,65 m³
Portata massima	Maximum load	120 kg

Versione alta	Version high	
Peso netto	Net weight	8 kg
Peso con imballo (1 sedia)	Packed weight (1 chair)	11,5 kg
Peso con imballo (2 sedie)	Packed weight (2 chairs)	19 kg
Volume imballo	Packed volume	0,65 m³
Portata massima	Maximum load	120 kg

BEDROOM



INNTIL

LETTO BED

PER RETE:
180x200: 1L4MO00905

Altri prodotti della collezione Inntil: pag. 22
Other products from Inntil collection: pag. 22



Design e relax. Il letto di linea ben modellata ha una struttura in legno ricoperta di materiale indeformabile e rivestita in tessuto. La prerogativa è il lungo cuscino-poggiatesta a incastro che funge da testiera. Il pattern tessile per vestire entrambi gli elementi sfoderabili è a scelta tra le proposte Missoni Home Collection. In varie misure e fornito con supporti poggia-rete.

Design and relax. This well-designed bed has a wooden structure covered in a non-deformable padding and upholstery fabric. The main design feature is the long back cushion that acts as a headboard. Upholstery to be chosen from fabrics in the Missoni Home Collection. Available in various sizes and supplied with slats frame supports (slats frame sold separately).

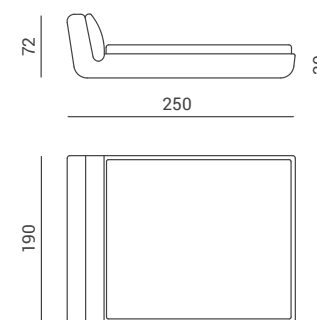

Le misure del letto variano in funzione del materasso richiesto. Esempio per materasso da 180x200 cm
Size of the bed vary according to the mattress required.
Example for a 180x200 cm mattress

INNTIL

LETTO BED

design by
MISSONI STUDIO
Made in Italy

Materiali - Materials

Struttura del giroletto: legno multistrato con giunzioni e supporto rete in acciaio

Imbottitura: poliuretano espanso indeformabile, rivestito di ovatta in fibra di poliestere

Rivestimento: tessuto sfoderabile, lavabile secondo le indicazioni riportate sull'etichetta

Piedini: gomma morbida antiscivolo e antigraffio

Rete e materasso - Slats frame and mattress

Supporti poggia-rete regolabili a 5 altezze.
Rete e materasso disponibili su richiesta



INDOOR



RIVESTIMENTO SFODERABILE
REMOVABLE COVER

Bed frame structure: plywood with steel joints and slats frame supports

Padding: non-deformable polyurethane foam covered with polyester fiber wadding

Upholstery: removable fabric, washable according to the instructions on the label

Feet: anti-slip and non-scratch soft rubber

*Slats frame supports adjustable to 5 heights.
Slats frame and mattress available on request*



Peso - Weight

Il peso del letto varia in funzione del materasso richiesto. Esempio per materasso da 180x220 cm

Peso netto	Net weight	75 kg
Peso con imballo	Packed weight	80 kg
Volume imballo	Packed volume	3,5 m³

*Weight of the bed vary according to the mattress required.
Example for a 180x220 cm mattress*

ONIRO

LETTO BED

PER RETE:
180x200: 1B4MO00007

ONIRO

LETTO BED

design by
MISSONI STUDIO
Made in Italy



INDOOR



RIVESTIMENTO SFODERABILE
REMOVABLE COVER

Materiali - Materials

Struttura: multistrato di abete e acciaio

Imbottitura: poliuretano ad alta densità a quote differenziate

Rivestimento: tessuto sfoderabile, lavabile secondo le indicazioni riportate sull'etichetta

Piedini: in plastica antiscivolo con punto al suolo in gomma e feltrini in lana ad alta densità

Structure: fir multi-layered wood and steel

Padding: high density polyurethane foam in varied densities

Upholstery: removable fabric, washable according to the instructions on the label

Feet: anti-scratch with rub and high density wool

Rete e materasso - Slats frame and mattress

Supporti poggia-rete regolabili a 5 altezze.
Rete e materasso disponibili su richiesta

Slats frame supports adjustable to 5 heights.
Slats frame and mattress available on request

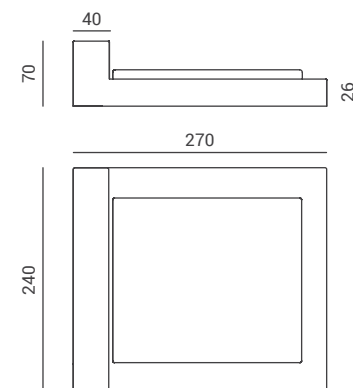

Dettagli essenziali. Di stile volutamente semplice e minimale, il letto appena ammorbidito dall'imbottitura punta sull'unicità del pattern di rivestimento. Dettaglio innovativo è il disegno della base sporgente che lo contorna creando un funzionale punto di appoggio. Cover da realizzare in qualsiasi tessuto a scelta della Missoni Home Collection. In diverse misure. Fornito di supporti poggia-rete.

Essential details. Of an intentional simple and minimal style, the bed barely softened by the padding relies on the uniqueness of the pattern of the cover. An innovative detail is the design of the protruding base that surrounds it creating a functional support. Cover to be made in any fabric of choice from the Missoni Home Collection. In various sizes. Provided with bedspring supports.

Le misure del letto variano in funzione del materasso richiesto. Esempio per materasso da 180x200 cm
Size of the bed vary according to the mattress required.
Example for a 180x200 cm mattress

Peso - Weight

Il peso del letto varia in funzione del materasso richiesto. Esempio per materasso da 180x220 cm

Weight of the bed vary according to the mattress required. Example for a 180x220 cm mattress

Peso netto	Net weight	120 kg
Peso con imballo	Packed weight	130 kg
Volume imballo	Packed volume	0,79 m³

SCREEN

LETTO BED

SCREEN (PER RETE):
180x200: 1L4M000219

SCREEN HIGH (PER RETE):
180x200: 1R4M000201



Rifugio schermato. L'importanza della testiera design che supporta, avvolge e scherma il letto, è il punto focale e l'elemento variabile del progetto. Struttura e giroletto in legno imbottito sono ricoperti in tessuto a scelta di Missoni Home Collection. Il rivestimento è posizionato con cura nel rispetto dei pattern. Testiera in diverse proporzioni. Letto in diverse misure, con supporti poggia-rete.

A place to retreat. The importance of the headboard is that it supports, wraps and screens the bed, it is the focal point of the design. The structure and wood bed frame are upholstered in fabric chosen from the Missoni Home Collection and carefully positioned to respect the pattern of the fabric. The headboard is available in different proportions. Bed available in different sizes, with slats frame supports.

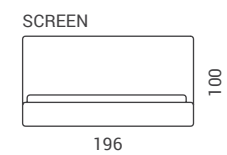
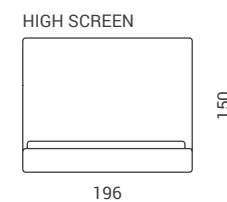
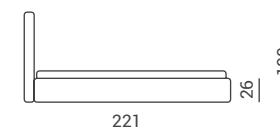
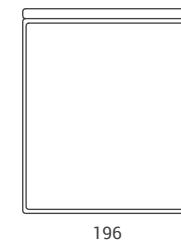

Le misure del letto variano in funzione del materasso richiesto. Esempio per materasso da 180x200 cm
Size of the bed vary according to the mattress required. Example for a 180x200 cm mattress

SCREEN

LETTO BED

design by
MISSONI STUDIO
Made in Italy

Materiali - Materials

Struttura del giroletto: legno multistrato con giunzioni e supporto rete in acciaio

Imbottitura: poliuretano espanso indeformabile, rivestito di ovatta in fibra di poliestere

Rivestimento: tessuto sfoderabile, lavabile secondo le indicazioni riportate sull'etichetta

Piedini: gomma morbida antiscivolo e antigraffio

Rete e materasso - Slats frame and mattress

Supporti poggia-rete regolabili a 5 altezze.
Rete e materasso disponibili su richiesta



INDOOR



RIVESTIMENTO SFODERABILE
REMOVABLE COVER

Bed frame structure: plywood with steel joints and slats frame supports

Padding: non-deformable polyurethane foam covered with polyester fiber wadding

Upholstery: removable fabric, washable according to the instructions on the label

Feet: anti-slip and non-scratch soft rubber

Slats frame supports adjustable to 5 heights. Slats frame and mattress available on request



Peso - Weight

Il peso del letto varia in funzione del materasso richiesto. Esempio per materasso da 180x200 cm

Weight of the bed vary according to the mattress required. Example for a 180x200 cm mattress

Versione Version	Peso netto Net weight	Peso con imballo Packed weight	Volume imballo Packed volume
High High	75 kg	80 kg	3,5 m ³
Senza ante Without side panels	70 kg	80 kg	2,4 m ³

PONENTE

PARAVENTO SCREEN

3 ANTE H140: 1B4M000008
3 ANT H180: 1B4M000009



Coreografia e stile. Il paravento decorativo è composto da tre pannelli, collegati da cerniere in acciaio. La struttura, esclusivamente da indoor, si può foderare in qualsiasi tessuto della collezione. Nella scelta del rivestimento per uno speciale effetto double-face si può optare per una coppia di tessuti da selezionare tra le proposte della Home. Disponibile nelle due dimensioni h140 e h180 cm. Non sfoderabile.

Choreography and style. The decorative screen is made up of three panels, connected by steel hinges. The structure, exclusively for indoors, can be covered in any fabric of the collection. In the choice of covering for a special reversible effect, it is possible to choose a pair of fabrics from the Home selection. Available in two sizes H 140 and H 180 cm. Not removable.



Dettaglio Detail

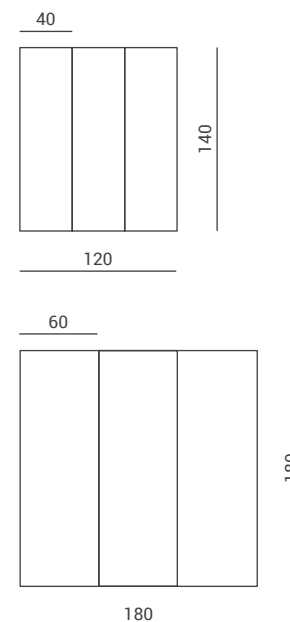

PONENTE

PARAVENTO SCREEN

design by
MISSONI STUDIO
Made in Italy

Materiali - Materials

Struttura: multistrato di abete
Imbottitura: ovatta di poliestere
Rivestimento: tessuti della collezione
Piedini: in lana ad alta densità
Sistema di aggancio fra le ante: cerniere in acciaio



INDOOR

*Structure: fir multi-layered wood
Padding: polyester fiberfill
Upholstery: collection's fabrics
Feet: high density wool
Linking system for the panels: steel hinge*



Versione alta	High version		Versione bassa	Low version	
Peso netto	Net weight	16 kg	Peso netto	Net weight	10,5 kg
Peso con imballo	Packed weight	18 kg	Peso con imballo	Packed weight	12,5 kg
Volume imballo	Packed volume	0,09 m³	Volume imballo	Packed volume	0,05 m³

OUTDOOR



TEKTONIK OUTDOOR

DIVANO MODULARE MODULAR SOFA

CUSCINO: 1C4M000105
 POUF: 1C4M000101
 BRACCIOLO: 1C4M000100
 SCHIENALE: 1C4M000102
 SEDUTA GRANDE: 1C4M000104
 SEDUTA PICCOLA: 1C4M000103

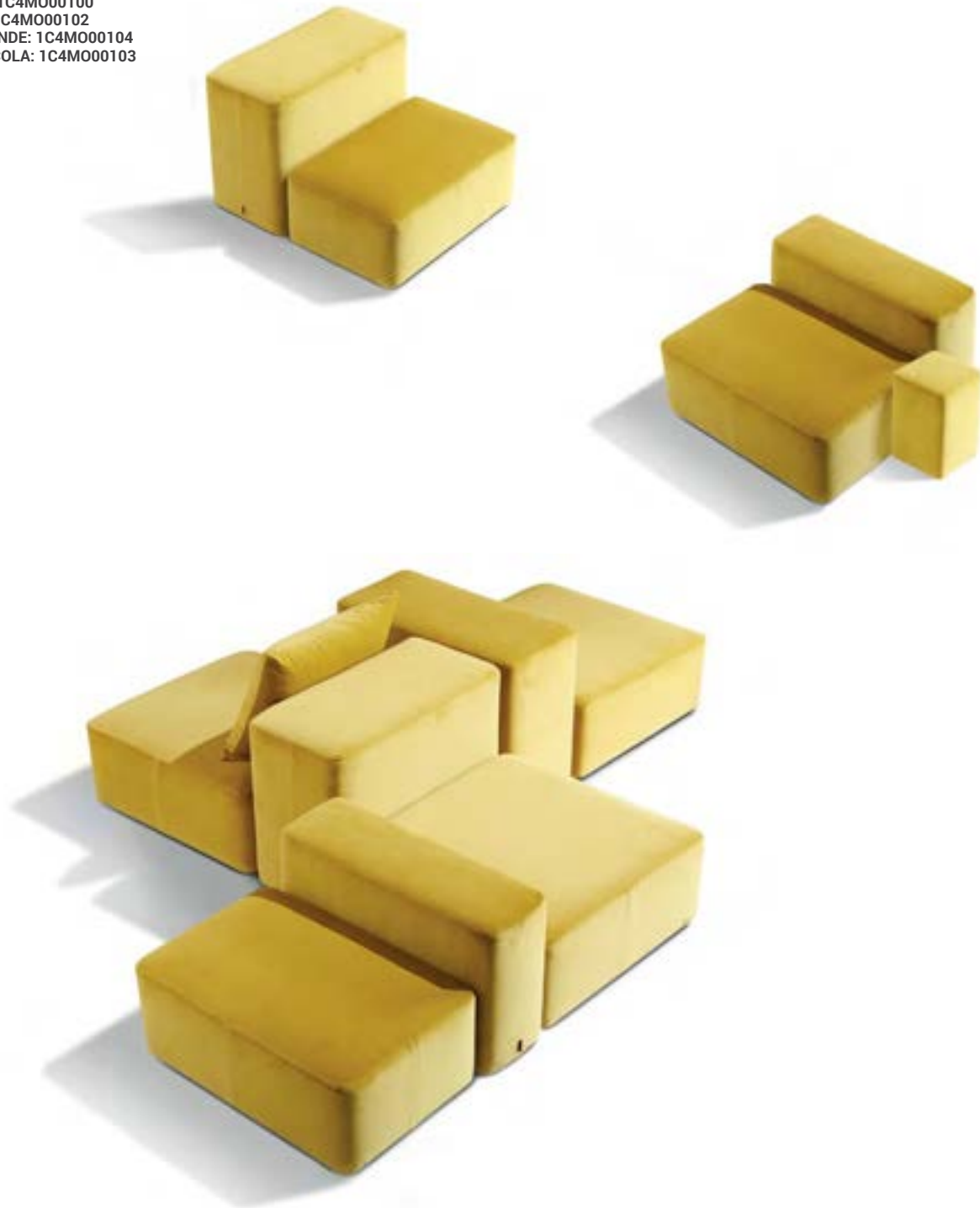

Semplice, composto. Sistema personalizzabile di sedute indipendenti, accostabili e bloccate da barre antisdrucchiolo. I moduli solidi e scultorei consentono un gioco di alternanze e geometrie valorizzato dalla disposizione e dal rivestimento. Tessuti d'arredamento a scelta di Missoni Home Collection. Suggesta l'aggiunta di un cuscino poggiatesta per ogni seduta.

Simple, composed. This customisable system of independent seat modules are joined and locked by anti-slip bars. The solid and sculptural modules allow a play of different compositions and geometries and enhanced by the choice of Upholstery: to be chosen from furnishing fabrics in the Missoni Home Collection. The addition of back cushion is recommended for each seat module.

CUSCINO POGGIARENI BACK CUSHION

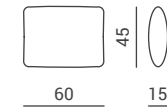

POUF

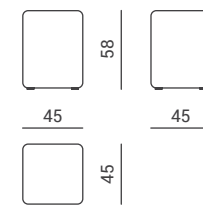

BRACCIOLO ARMREST

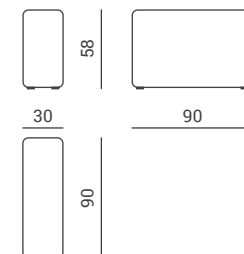

SCHIENALE BACK

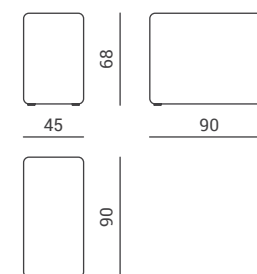

SEDUTA PICCOLA SMALL SEAT

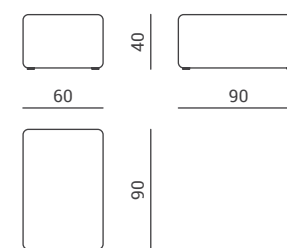

SEDUTA GRANDE LARGE SEAT

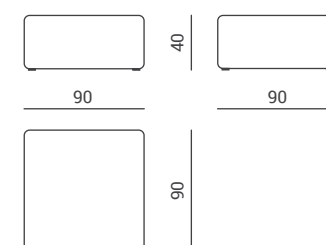

TEKTONIK

DIVANO MODULARE MODULAR SOFA

design by
BENDIK TORVIN
 Made in Italy

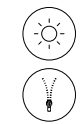

OUTDOOR

RIVESTIMENTO SFODERABILE
 REMOVABLE COVER

Materiali - Materials

Struttura: legno multistrato con fondo in multistrato marino con sospensione su cinghie elastiche

Imbottitura: poliuretano espanso indeformabile a quote differenziate, rivestito con tela impermeabile

Rivestimento: tessuto per esterno sfoderabile, lavabile secondo le indicazioni riportate sull'etichetta

Sistema di aggancio fra moduli: ad incastro rapido, predisposti in base alla composizione scelta

Piedini: plastica antiscivolo e antigraffio

Structure: hardwood plywood and bottom in marine plywood

Padding: open-cell polyurethane in different densities, covered with water repellent fabric

Upholstery: removable outdoor fabric, washable according to the fabric specifications

Coupling system between modules: quick-interlock, arranged according to the chosen composition

Feet: anti-slip and non-scratch plastic

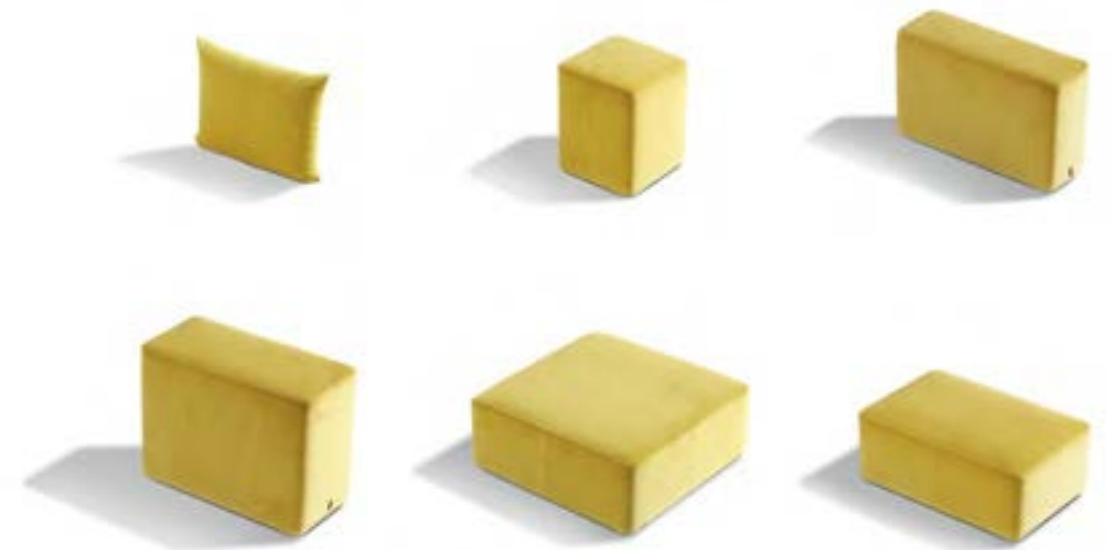

Modulo Unit	Peso netto Net weight	Peso con imballo Packed weight	Volume imballo Packed volume
Cuscino poggiatesta Back cushion	1,5 kg	1,5 kg	0,05 m ³
Pouf Pouf	13,5 kg	17 kg	0,2 m ³
Bracciolo Arm	18 kg	22 kg	0,3 m ³
Schienale Back	24 kg	28 kg	0,4 m ³
Seduta grande Large seat	20 kg	25 kg	0,5 m ³
Seduta piccola Small seat	15 kg	19 kg	0,4 m ³
Portata massima per modulo Maximum load per module		100 kg	

VIRGOLA SOFT

SEDUTA SEATING

1A4M000100

VIRGOLA SOFT

SEDUTA SEATING

design by
MISSONI STUDIO
Made in Italy



INDOOR



OUTDOOR



RIVESTIMENTO SFODERABILE
REMOVABLE COVER

Materiali - Materials

Struttura: microsfere di polipropilene e fibra di poliestere
Rivestimento: sfoderabile, in tessuto idrorepellente e antimacchia

Structure: polypropylene microbeads and polyester fibre
Cover: removable, in water repellent and stain proof fabric



New shape, indoor/outdoor. La versione Soft di Virgola offre isole relax attraenti e paffute, estremamente accoglienti e resilienti. La nuova modellatura è stata progettata per aumentare il comfort e garantire la doppia performance outdoor/indoor. Protetta da rivestimenti in canvas waterproof la seduta ha finiture molto accurate e resistenti. L'imbottitura a microsfere di polipropilene offre una compattezza invitante, morbida, graduata.

New shape, indoor/outdoor. The Soft version of the Virgola is an attractive and plump relaxation island, extremely welcoming and resilient. The new shaping has been designed to increase comfort and guarantee double performance for outdoor/indoor. Protected by waterproof canvas covers, the seat has a very high-tech and resistant finish. The polypropylene microsphere padding offers an inviting, soft and graduated compactness.

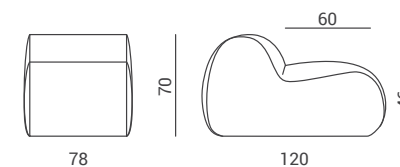

Peso netto	Net weight	10 kg
Peso con imballo	Packed weight	13 kg
Volume imballo	Packed volume	0,7 m³
Portata massima	Maximum load	120 kg

JALAMAR OUTDOOR

CHAISE LONGUE LOUNGER

1P4M000900

JALAMAR OUTDOOR

CHAISE LONGUE LOUNGER

design by
CRISTIANO MAGNONI
Made in Italy

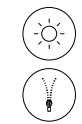

OUTDOOR

RIVESTIMENTO SFODERABILE
REMOVABLE COVER

Materiali - Materials

Struttura: in acciaio con meccanismi a scatto da 5 posizioni per lo schienale e 3 posizioni per le gambe

Imbottitura: poliuretano espanso indeformabile, rivestito di ovatta in fibra di poliestere

Rivestimento: tessuto sfoderabile idrorepellente e antimacchia, lavabile secondo le indicazioni riportate sull'etichetta

Structure: in steel with 5-position adjustable mechanism for the backrest and 3-position for the leg rest

Padding: non-deformable polyurethane foam covered with polyester fiber wadding

Upholstery: removable fabric, water repellent and stain resistant, washable according to the instructions on the label

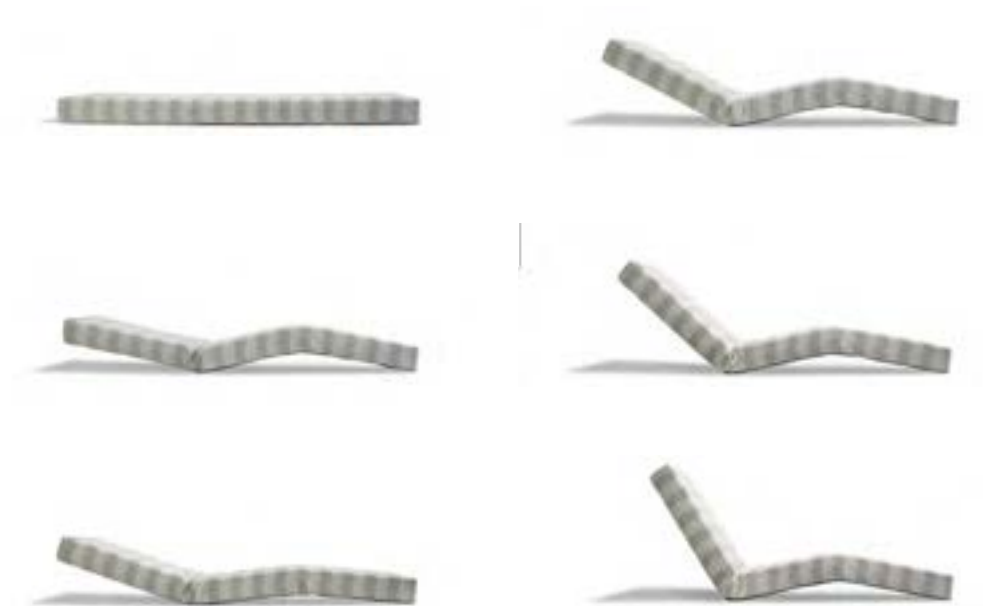

Comfort outdoor. La chaise longue anatomica da esterni è un elemento confortevole e decorativo. Il materassino azionato da meccanismi interni assume diverse inclinazioni, 5 per lo schienale, 3 per il poggiatesta. Rivestimento a scelta tra i tessuti Missoni Home Collection. La parte inferiore del cover è idrorepellente, antimuffa e antimacchia, per l'appoggio a terra.

Outdoor comfort. This chaise longue offers anatomical comfort and a decorative aesthetic. The mattress is operated by an internal mechanism that adjusts inclinations, 5 positions for the backrest and 3 for the leg-rest. Upholstery to be chosen from outdoor fabrics from the Missoni Home Collection. As it is positioned directly on the floor, the base is made from water-repellent, anti-mould and anti-stain fabric.

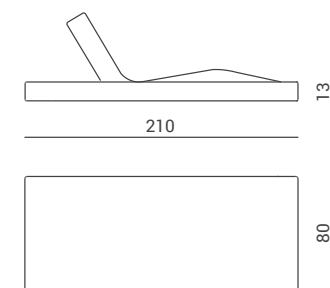

Peso netto	Net weight	20 kg
Peso con imballo	Packed weight	24 kg
Volume imballo	Packed volume	0,3 m³
Portata massima	Maximum load	100 kg

REGISTA

SEDIA CHAIR

WHITE: 1M4M000002



BIANCO
NATURALE

REGISTA

SEDIA CHAIR

design by
MISSONI STUDIO
Made in Italy

Materiali - Materials

Struttura: legno di frassino impregnato a due mani per utilizzo nautico

Sedile e schienale: tessuto per esterno removibile, lavabile secondo le indicazioni riportate sull'etichetta



INDOOR



OUTDOOR



RIVESTIMENTO SFODERABILE
REMOVABLE COVER

Structure: ash wood, double-impregnated for nautical usage

Seat and back: removable outdoor fabric, washable according to the instructions on the label



Evergreen, funzionale. Semplicità e intrinseca qualità estetica, la sedia da regista è realizzata con struttura in legno di faggio a verniciatura waterproof e ha seduta e schienale in tessuto da outdoor facilmente sfilabili. Rivestimento a scelta tra i tessuti d'arredamento Missoni Home Collection. La sedia è ripiegabile.

Evergreen, functional. Simplicity with an intrinsic aesthetic quality, this director's chair is made of beech wood with a waterproof varnish finish. The outdoor fabric of the seat and back is easily removable and can be chosen from furnishing fabrics of the Missoni Home Collection. Foldable.

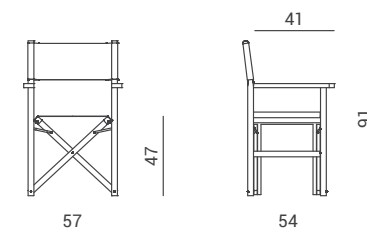

Peso netto	Net weight	6 kg
Peso con imballo	Packed weight	10 kg
Volume imballo	Packed volume	0,13 m³
Portata massima	Maximum load	100 kg

TESSUTI
INDOOR
INDOOR
FABRICS



INDOOR



ACONCAGUA
1A4Q003 - Col. 100
140 CM - 55 IN
35% PL - 34% AC - 27% PA - 4% PC



AGADIR
1A4Q019 - Col. 159
140 CM - 55 IN
76% CO - 24% PL



AMARILLO
1A4Q008 - Col. 100
130 CM - 51 IN
61% PL - 16% CO - 14% AC - 8% PC - 1% SE



BASEL
1B4P001 - Col. 22
140 CM - 55 IN
100% CO



BASTIA
1B4Q004 - Col. 148
140 CM - 55 IN
100% PL

A.F



BELFAST
1B4Q023 - Col. 100
140 CM - 55 IN
100% PL

A.F



ANDE NEW
1A4Q004 - Col. 162
130 CM - 51 IN
65% PL - 23% PC - 12% WO



ANEMONE NEW
1C4Q025 - Col. 164
145 CM - 57 IN
86% PL - 14% CO



ANEMONE NEW
1C4Q025 - Col. 165
145 CM - 57 IN
86% PL - 14% CO

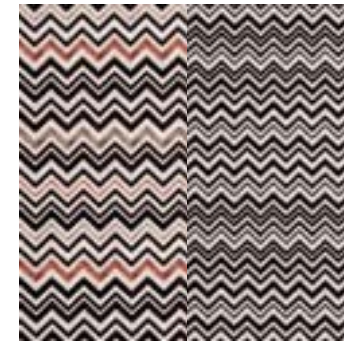

BELFAST
1B4Q023 - Col. 160 / 160R
140 CM - 55 IN
100% PL

A.F



BETULLA NEW
1C4Q002 - Col. 148
145 CM - 57 IN
66% PL - 17% PC - 17% WO



BETULLA NEW
1C4Q002 - Col. 601
145 CM - 57 IN
66% PL - 17% PC - 17% WO



ANVERSA
1A4Q014 - Col. 159
135 CM - 53 IN
92% VI - 8% PL



ARRAS
1A4Q012 - Col. 100
140 CM - 55 IN
100% PL

A.F



BAKU
1B4Q010 - Col. 149 / 149R
135 CM - 53 IN
74% PL - 16% CO - 8% PC - 2% AC



BIRMINGHAM
1B4Q021 - Col. 157
140 CM - 55 IN
100% PL

A.F



BIRMINGHAM
1B4Q021 - Col. 160
140 CM - 55 IN
100% PL



BLEACHED NEW
1C4Q018 - Col. 150
140 CM - 55 IN
39% PL - 17% PC - 15% VI - 12% WO - 7% WC

INDOOR



BLEACHED NEW
1C4Q018 - Col. 153
140 CM - 55 IN
39%PL - 17%PC - 15%VI - 12%WO - 7%WC



BLEACHED NEW
1C4Q018 - Col. 160
140 CM - 55 IN
39%PL - 17%PC - 15%VI - 12%WO - 7%WC

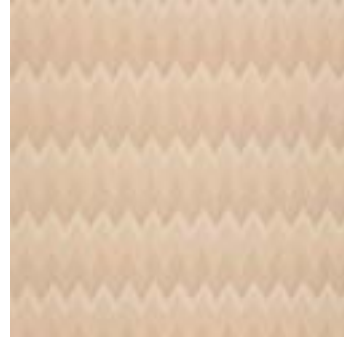

BREST
1B4Q005 - Col. 481
140 CM - 55 IN
100% PL

A.F. ●



COLUMBIA FR NEW
1C4Q027- Col. 21
130 CM - 51 IN
100%PL



COLUMBIA FR NEW
1C4Q027- Col. 25
130 CM - 51 IN
100%PL



COLUMBIA FR NEW
1C4Q027 - Col. 50
130 CM - 51 IN
100%PL



BREST
1B4Q005 - Col. 861
140 CM - 55 IN
100% PL

A.F. ●



BROOKLYN
1B4Q007 - Col. 159
140 CM - 55 IN
38% PC - 38% WO - 14% PA - 10% PL



BROUGES NEW
1C4Q022- Col. 156
130 CM - 51 IN
47%VI - 30%WO - 20%PA - 3%PL

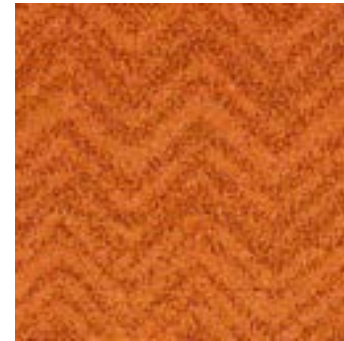

COLUMBIA FR NEW
1C4Q027- Col. 59
130 CM - 51 IN
100%PL

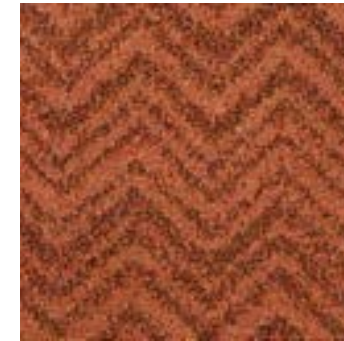

COLUMBIA FR NEW
1C4Q027- Col. 64
130 CM - 51 IN
100%PL



COOMBA
1H4PK03 - Col. 21
140 CM - 55 IN
62% VI - 38% CO

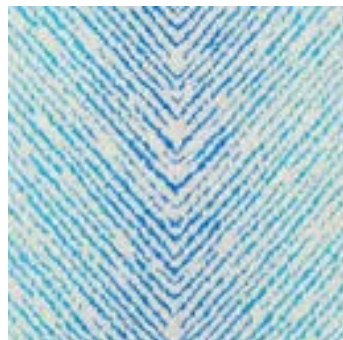

BROUGES NEW
1C4Q022 - Col. 174
130 CM - 51 IN
47%VI - 30%WO - 20%PA - 3%PL

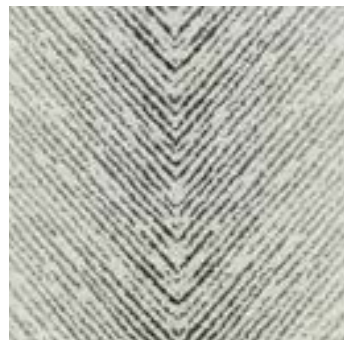

BROUGES NEW
1C4Q022 - Col. 601
130 CM - 51 IN
47%VI - 30%WO - 20%PA - 3%PL

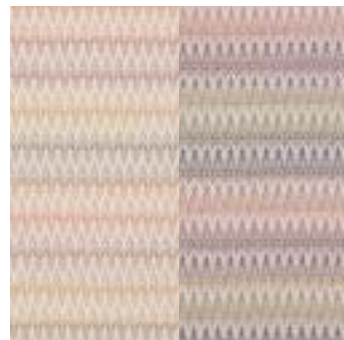

BRUGES NEW
1B4Q011 - Col. 148 / 148R
130 CM - 51 IN
47% CO - 38% PL - 10% PC - 5% PM

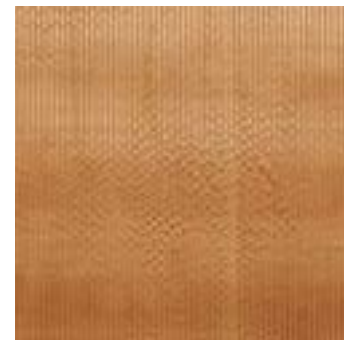

COOMBA
1H4PK03 - Col. 62
140 CM - 55 IN
62% VI - 38% CO

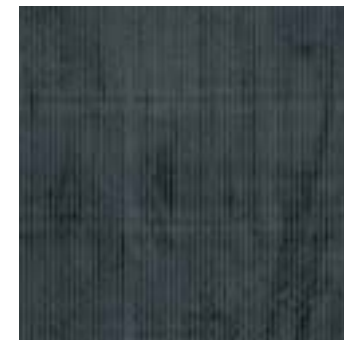

COOMBA
1H4PK03 - Col. 86
140 CM - 55 IN
62% VI - 38% CO



COOMBA
1H4PK03 - Col. T40
140 CM - 55 IN
62% VI - 38% CO

INDOOR



COOMBA

1H4PK03 - Col. T49
140 CM - 55 IN
62% VI - 38% CO

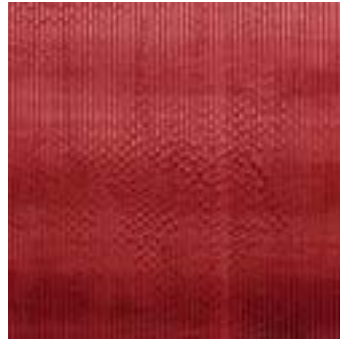

COOMBA

1H4PK03 - Col. T56
140 CM - 55 IN
62% VI - 38% CO



COOMBA

1H4PK03 - Col. T57
140 CM - 55 IN
62% VI - 38% CO

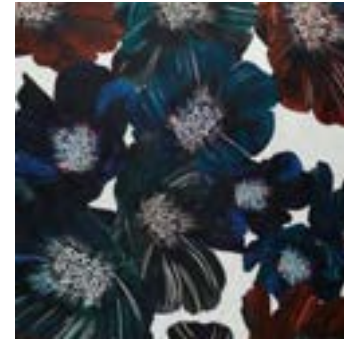

FIREFLOWERS NEW

1C4R002 - Col. 150
135 CM - 53 IN
100%CO



FIREFLOWERS_LANA NEW

1C4R003 - Col. 148
140 CM - 55 IN
100%WO



FIREFLOWERS_LANA NEW

1C4R003 - Col. 150
140 CM - 55 IN
100%WO



COOMBA

1H4PK03 - Col. T59
140 CM - 55 IN
62% VI - 38% CO



COOMBA

1H4PK03 - Col. T65
140 CM - 55 IN
62% VI - 38% CO



COOMBA

1H4PK03 - Col. T70
140 CM - 55 IN
62% VI - 38% CO



GLITCH NEW

1C4Q014 - Col. 601
150 CM - 59 IN
59%WO - 26%CO - 15%PL



JACARANDA

1H4QK19 - Col. T50
135 CM - 53 IN
92% VI - 8% PL



JACARANDA

1H4QK19 - Col. T59
135 CM - 53 IN
92% VI - 8% PL



DAMIER NEW

1C4Q015 - Col. 121
135 CM - 53 IN
50%CO - 42%PL - 8%PC

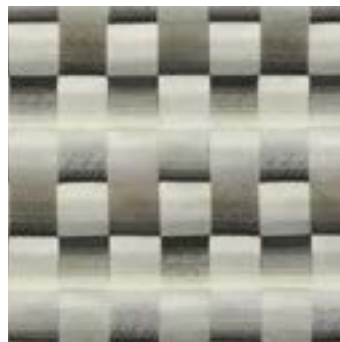

DAMIER NEW

1C4Q015 - Col. 601
135 CM - 53 IN
50%CO - 42%PL - 8%PC



FIREFLOWERS NEW

1C4R002 - Col. 148
135 CM - 53 IN
100%CO



JARRIS

1J4RC55 - Col. 148
140 CM - 55 IN
100% CO



JARRIS

1J4RC55 - Col. 150
140 CM - 55 IN
100% CO



JARRIS

1J4RC55 - Col. 156
140 CM - 55 IN
100% CO

INDOOR

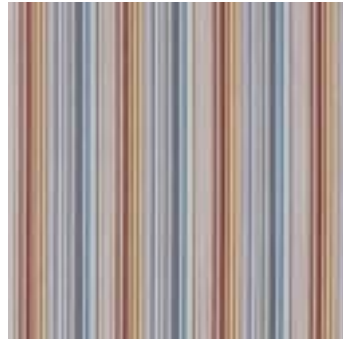

JENKINS

1J4QA11 - Col. 148
140 CM - 55 IN
100% CO

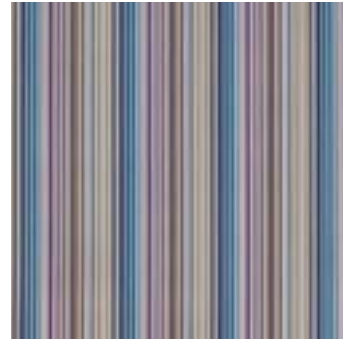

JENKINS

1J4QA11 - Col. 150
140 CM - 55 IN
100% CO



JENKINS

1J4QA11 - Col. 156
140 CM - 55 IN
100% CO



LAYERS_INLAY NEW

1C4R001 - Col. 50
140 CM - 55 IN
100% CO

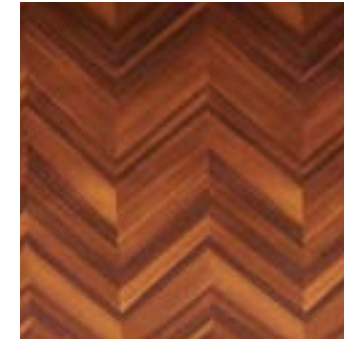

LAYERS_INLAY NEW

1C4R001 - Col. 64
140 CM - 55 IN
100% CO



LAYERS_INLAY NEW

1C4R001 - Col. 65
140 CM - 55 IN
100% CO



JERSEY

1J4RC54 - Col. 148
140 CM - 55 IN
100% CO



JERSEY

1J4RC54 - Col. 156
140 CM - 55 IN
100% CO



KEW

114Q016 - Col. 170
150 CM - 59 IN
61% CO - 29% PL - 10% SE



LIBERTAD

1L4QK24 - Col. 140
135 CM - 53 IN
100% VI



LIBERTAD

1L4QK24 - Col. 159
135 CM - 53 IN
100% VI



LOBELIA

1L4RC68 - Col. 159
145 CM - 57 IN
100% CO



KEW

114Q016 - Col. T59
150 CM - 59 IN
61% CO - 29% PL - 10% SE



LAYERS_INLAY NEW

1C4R001 - Col. 21
140 CM - 55 IN
100% CO

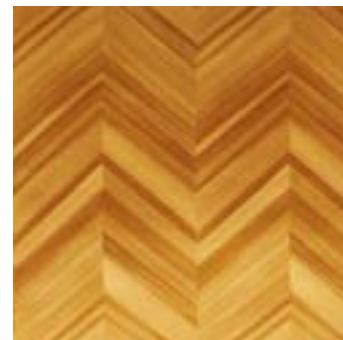

LAYERS_INLAY NEW

1C4R001 - Col. 40
140 CM - 55 IN
100% CO



LOBOS

1L4RC69 - Col. 159
145 CM - 57 IN
100% CO



MASEKO

1M4QK26 - Col. 156
135 CM - 53 IN
100% VI



MASEKO

1M4QK26 - Col. 160
135 CM - 53 IN
100% VI

INDOOR



MASULEH
1M4Q053 - Col. 131
145 CM - 57 IN
45% PL - 42% AC - 13% SE



MASULEH
1M4Q053 - Col. 156
145 CM - 57 IN
45% PL - 42% AC - 13% SE



MASULEH
1M4Q053 - Col. 170
145 CM - 57 IN
45% PL - 42% AC - 13% SE



NASTRI NEW
1C4Q017 - Col. 601
140 CM - 55 IN
51%CO - 20%VI - 16%PL - 13%PC

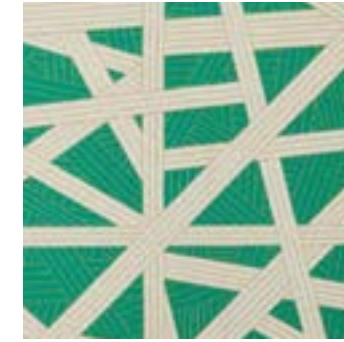

NASTRI NEW
1C4Q017 - Col. 651A
140 CM - 55 IN
51%CO - 20%VI - 16%PL - 13%PC



NOISE NEW
1C4Q016 - Col. 601
140 CM - 55 IN
25%PL - 20%CO - 20%VI - 19%PC - 16%WO



MIDNIGHT_GARDEN NEW
1C4Q010 - Col. 160
150 CM - 59 IN
64%CO - 31%PL - 5%PA



MILANO NEW
1C4Q005 - Col. 148
135 CM - 53 IN
39%CO - 35%PL - 26%PA



NASTRI NEW
1C4Q017 - Col. 251
140 CM - 55 IN
51%CO - 20%VI - 16%PL - 13%PC



NUVOLA NEW
1C4P001 - Col. 21
135 CM - 53 IN
89%CO - 11%PL

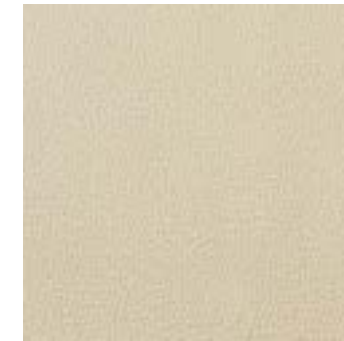

NUVOLA NEW
1C4P001 - Col. 48
135 CM - 53 IN
89%CO - 11%PL



NY NEW
1C4Q001 - Col. 160
130 CM - 51 IN
93%PL - 7%PC

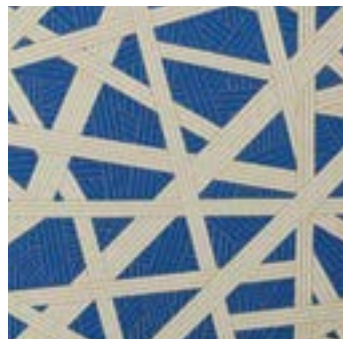

NASTRI NEW
1C4Q017 - Col. 501
140 CM - 55 IN
51%CO - 20%VI - 16%PL - 13%PC



NASTRI NEW
1C4Q017 - Col. 531
140 CM - 55 IN
51%CO - 20%VI - 16%PL - 13%PC



NASTRI NEW
1C4Q017 - Col. 591
140 CM - 55 IN
51%CO - 20%VI - 16%PL - 13%PC

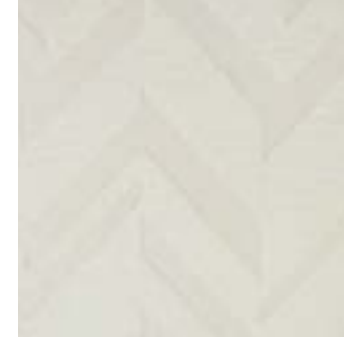

ORME NEW
1C4Q003 - Col. 20
135 CM - 53 IN
49%PC - 18%PL - 14%CO



ORME NEW
1C4Q003 - Col. 50
135 CM - 53 IN
49%PC - 18%PL - 14%CO

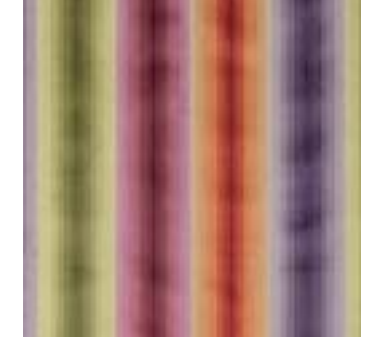

PARAGUAY
1P4Q001 - Col. 100
135 CM - 53 IN
100% VI

INDOOR

INDOOR



PARIGI NEW
1C4Q009 - Col. 160
150 CM - 59 IN
58%CO - 42%PL



PASADENA
1P4Q002 - Col. 100
130 CM - 51 IN
53% PL - 38% CO - 9% PC



PASSIFLORA
1H4RC45 - Col. T50
140 CM - 55 IN
100% CO



RAFAH
1R4Q015 - Col. 40
140 CM - 55 IN
68% CO - 32% VI

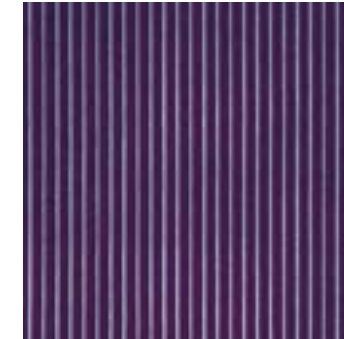

RAFAH
1R4Q015 - Col. 49
140 CM - 55 IN
68% CO - 32% VI



RAFAH
1R4Q015 - Col. 61
140 CM - 55 IN
68% CO - 32% VI



PASSIFLORA
1H4RC45 - Col. T59
140 CM - 55 IN
100% CO



PASSIFLORA
1H4RC45 - Col. T60
140 CM - 55 IN
100% CO



PASSIFLORA GIANT
1P4R003 - Col. 159
140 CM - 55 IN
100% CO

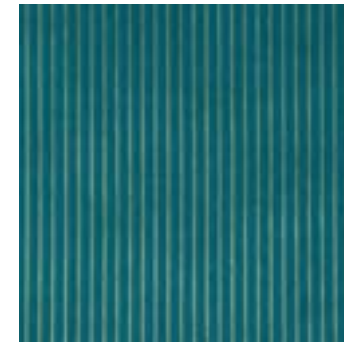

RAFAH
1R4Q015 - Col. 74
140 CM - 55 IN
68% CO - 32% VI

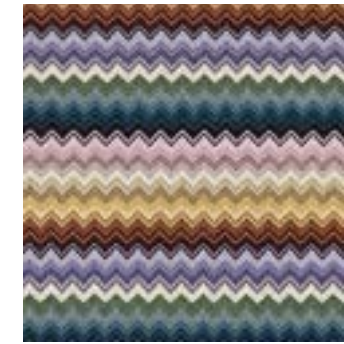

RAJAM
1R4Q020 - Col. 100
145 CM - 57 IN
46% PL - 42% CO - 12% PC



RAMAN
1R4R006 - Col. 100
145 CM - 57 IN
100% CO



PASSIFLORA GIANT
1P4R003 - Col. 170
140 CM - 55 IN
100% CO



PHRAE
1P4Q007 - Col. 100
145 CM - 57 IN
57% CO - 26% PL - 17% AC

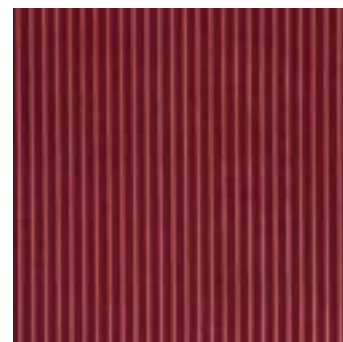

RAFAH
1R4Q015 - Col. 28
140 CM - 55 IN
68% CO - 32% VI



RAVENNA
1R4Q001 - Col. 149
135 CM - 53 IN
100% VI



RENO
1R4Q019 - Col. 156
140 CM - 55 IN
60% CO - 36% VI - 4% MD



ROING
1R4Q004 - Col. 100
140 CM - 55 IN
57% PL - 35% CO - 8% PC

INDOOR

INDOOR



ROYAL NEW
1C4Q008 - Col. 25
140 CM - 55 IN
62%WM - 38%CO



ROYAL NEW
1C4Q008 - Col. 50
140 CM - 55 IN
62%WM - 38%CO



ROYAL NEW
1C4Q008 - Col. 53
140 CM - 55 IN
62%WM - 38%CO



SCIA NEW
1C4Q021 - Col. 174
140 CM - 55 IN
62%VI - 27%CO - 7%PC - 4%PL



SCIA NEW
1C4Q021 - Col. 601
140 CM - 55 IN
62%VI - 27%CO - 7%PC - 4%PL



SHADE NEW
A - Col. 601
140 CM - 55 IN
73%CO - 19%PL - 8%PC



SAINT_REMY NEW
1C4Q020 - Col. 153
140 CM - 55 IN
56%VI - 19%CO - 18%LI - 3%PC



SAINT_REMY NEW
1C4Q020 - Col. 156
140 CM - 55 IN
56%VI - 19%CO - 18%LI - 3%PC



SAINT_REMY NEW
1C4Q020 - Col. 174
140 CM - 55 IN
56%VI - 19%CO - 18%LI - 3%PC



SHANGAI NEW
1C4R004 - Col. 150
140 CM - 55 IN
100%WO



SHANGAI NEW
1C4R004 - Col. 160
140 CM - 55 IN
100%WO



SNAKE NEW
1C4Q019 - Col. 153
150 CM - 59 IN
59%CO - 15%PL - 14%VI - 12%LI

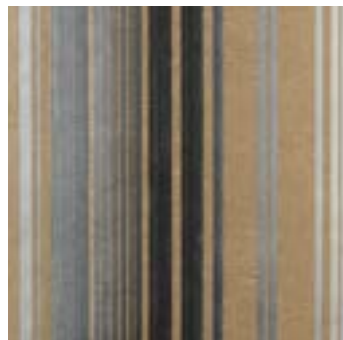

SAINT_REMY NEW
1C4Q020 - Col. 601
140 CM - 55 IN
56%VI - 19%CO - 18%LI - 3%PC

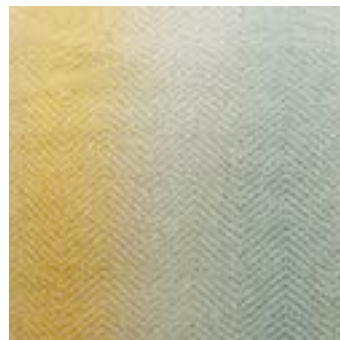

SCIA NEW
1C4Q021 - Col. 153
140 CM - 55 IN
62%VI - 27%CO - 7%PC - 4%PL



SCIA NEW
1C4Q021 - Col. 156
140 CM - 55 IN
62%VI - 27%CO - 7%PC - 4%PL



SNAKE NEW
1C4Q019 - Col. 157
150 CM - 59 IN
59%CO - 15%PL - 14%VI - 12%LI

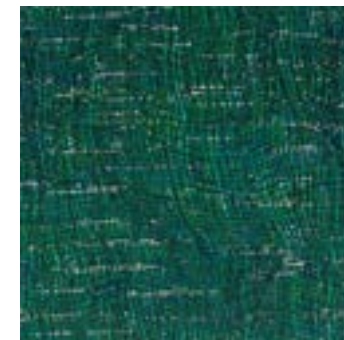

SNAKE NEW
1C4Q019 - Col. 165
150 CM - 59 IN
59%CO - 15%PL - 14%VI - 12%LI

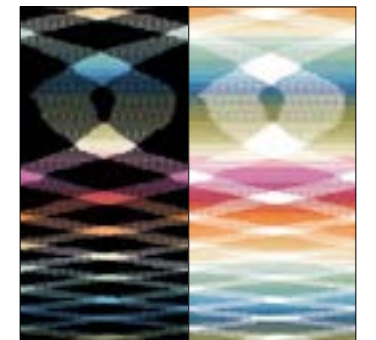

STOCCARDA
1S4Q024 - Col. 160 / 160R
150 CM - 59 IN
100% PL

A.F.

INDOOR



TILE NEW
1C4Q012 - Col. 531
150 CM - 59 IN
100%PL



TILE NEW
1C4Q012 - Col. 601
150 CM - 59 IN
100%PL



TILE NEW
1C4Q012 - Col. 651
150 CM - 59 IN
100%PL



TREAD NEW
1C4Q004 - Col. 651
130 CM - 51 IN
86%PL - 14%PC

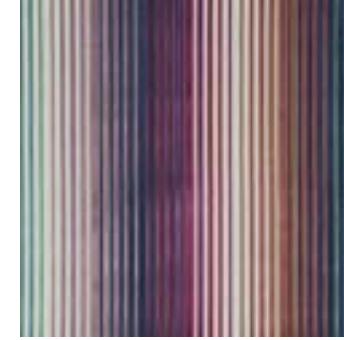

TUNISI
1T4Q006 - Col. 100
135 CM - 53 IN
100% VI



VANCOUVER
1V4R001 - Col. 100
135 CM - 53 IN
100% PL

A.F



TILE NEW
1C4Q012 - Col. 741
150 CM - 59 IN
100%PL

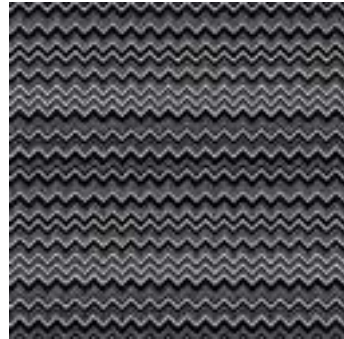

TOBAGO
1G4RC42 - Col. T20
140 CM - 55 IN
100% CO



TREAD NEW
1C4Q004 - Col. 401
130 CM - 51 IN
86%PL - 14%PC



VANCOUVER
1V4R001 - Col. 160
135 CM - 53 IN
100% PL

A.F



WISEN
1W4Q024 - Col. 22
140 CM - 55 IN
36% CO - 33% VI - 31% PL



WISEN
1W4Q024 - Col. 40
140 CM - 55 IN
36% CO - 33% VI - 31% PL



TREAD NEW
1C4Q004 - Col. 501
130 CM - 51 IN
86%PL - 14%PC



TREAD NEW
1C4Q004 - Col. 531
130 CM - 51 IN
86%PL - 14%PC



TREAD NEW
1C4Q004 - Col. 601
130 CM - 51 IN
86%PL - 14%PC



WISEN
1W4Q024 - Col. 49
140 CM - 55 IN
36% CO - 33% VI - 31% PL



WISEN
1W4Q024 - Col. 61
140 CM - 55 IN
36% CO - 33% VI - 31% PL



WISEN
1W4Q024 - Col. 74
140 CM - 55 IN
36% CO - 33% VI - 31% PL

INDOOR

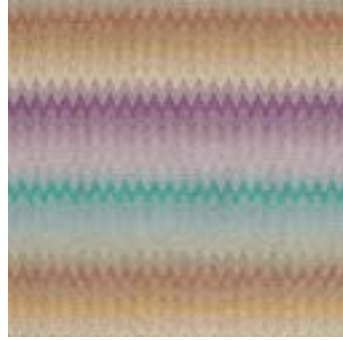

YAMAGATA
1Y4Q024 - Col. 100
140 CM - 55 IN
54% PL - 43% CO - 3% PM



YANAI
1Y4Q025 - Col. 100
150 CM - 59 IN
51% CO - 40% PL - 9% SE



YATE
1Y4Q026 - Col. 164
140 CM - 55 IN
100% PL

A.F. ●

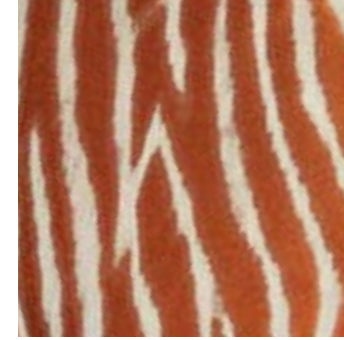

ZAMBIA NEW
1C4Q013 - Col. 641
150 CM - 59 IN
53%PL - 47%CO



ZAMBIA NEW
1C4Q013 - Col. 651
150 CM - 59 IN
53%PL - 47%CO



ZIGGY NEW
1C4Q006 - ACol. 571
140 CM - 55 IN
83%VI - 17%PL



YUGAWARA
1Y4Q002 - Col. 100
140 CM - 55 IN
92% VI - 8% PL

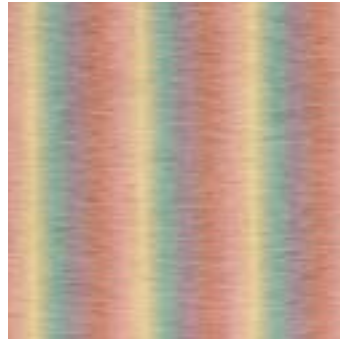

YUZA
1Y4Q030 - Col. 100
145 CM - 57 IN
80% CO - 20% PL

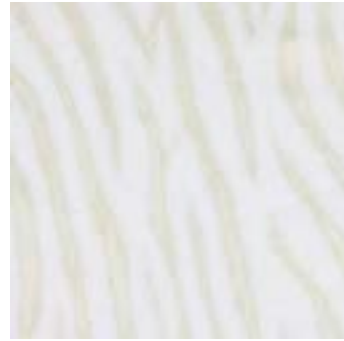

ZAMBIA NEW
1C4Q013 - Col. 211
150 CM - 59 IN
53%PL - 47%CO



ZIGGY NEW
1C4Q006 - Col. 601
140 CM - 55 IN
83%VI - 17%PL



ZIGGY NEW
1C4Q006 - Col. 651
140 CM - 55 IN
83%VI - 17%PL

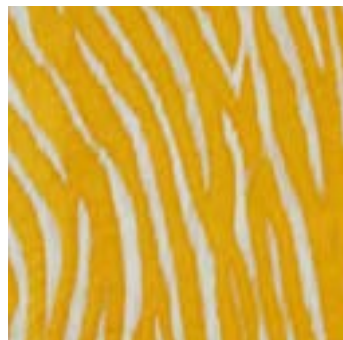

ZAMBIA NEW
1C4Q013 - Col. 531
150 CM - 59 IN
53%PL - 47%CO



ZAMBIA NEW
1C4Q013 - Col. 601
150 CM - 59 IN
53%PL - 47%CO



ZAMBIA NEW
1C4Q013 - Col. 621
150 CM - 59 IN
53%PL - 47%CO

A photograph of a sailboat deck, viewed from the front. The deck is made of light-colored wood and features two long, low-profile seating areas on either side of a central table. The seating areas are covered with cushions in a striped pattern of beige, brown, and white. Several matching striped pillows are placed on the cushions. In the center, a dark, rectangular table is visible. A small basket containing items is hanging from the mast. The background shows a vast blue sea under a clear blue sky with a few wispy clouds. In the distance, a range of mountains is visible on the horizon. The overall scene is bright and sunny, suggesting a pleasant day on the water.

TESSUTI
OUTDOOR
OUTDOOR
FABRICS

OUTDOOR



ATACAMA
1A4K001 - Col. 221
140 CM - 55 IN
100% PL

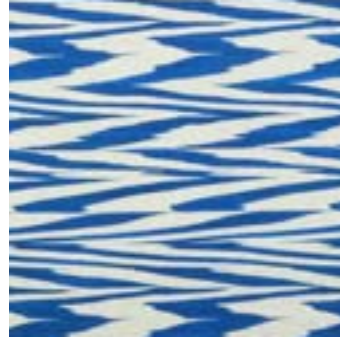

ATACAMA NEW
1A4K001 - Col. 501
140 CM - 55 IN
100%PL



ATACAMA NEW
1A4K001 - Col. 571
140 CM - 55 IN
100%PL



KEW MTC
1O4K009 - Col. 159
130 CM - 51 IN
100% PL



KEW MTC
1O4K009 - Col. 170
130 CM - 51 IN
100% PL



LAMB NEW
1C4K005 - Col. 20
140 CM - 55 IN
97%PL - 3%PA



ATACAMA
1A4K001 - Col. 591
140 CM - 55 IN
100% PL



ATACAMA
1A4K001 - Col. 601
140 CM - 55 IN
100% PL



ATACAMA
1A4K001 - Col. 621
140 CM - 55 IN
100% PL



LAMB NEW
1C4K005 - Col. 50
140 CM - 55 IN
97%PL - 3%PA



LAMB NEW
1C4K005 - Col. 53
140 CM - 55 IN
97%PL - 3%PA



LAMB NEW
1C4K005 - Col. 59
140 CM - 55 IN
97%PL - 3%PA



ATACAMA
1A4K001 - Col. 721
140 CM - 55 IN
100% PL



KEW BN
1O4K012 - Col. 601
130 CM - 51 IN
100% PL



KEW MTC
1O4K009 - Col. 100
130 CM - 51 IN
100% PL



MARMOR NEW
1C4K003 - Col. 148
145 CM - 57 IN
100%PC

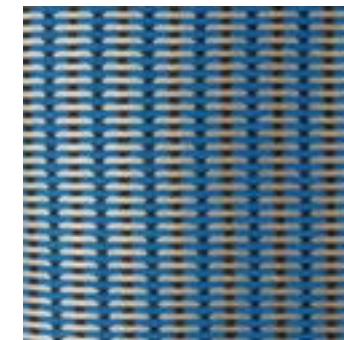

MOZART NEW
1C4K004 - Col. 150
140 CM - 55 IN
100%PL

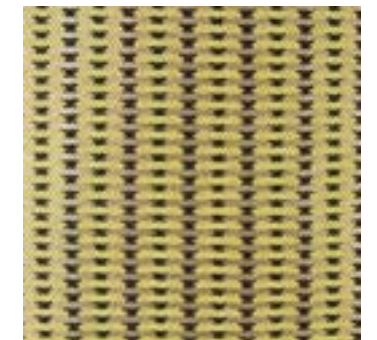

MOZART NEW
1C4K004 - Col. 153
140 CM - 55 IN
100%PL

OUTDOOR

OUTDOOR

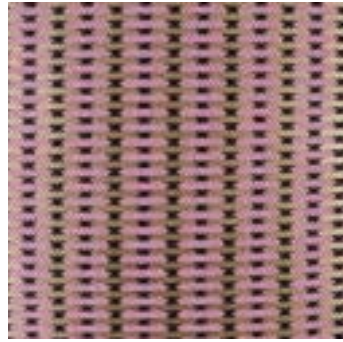

MOZART NEW
1C4K004 - Col. 157
140 CM - 55 IN
100%PL

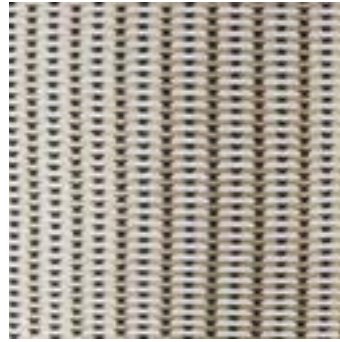

MOZART NEW
1C4K004 - Col. 160
140 CM - 55 IN
100%PL

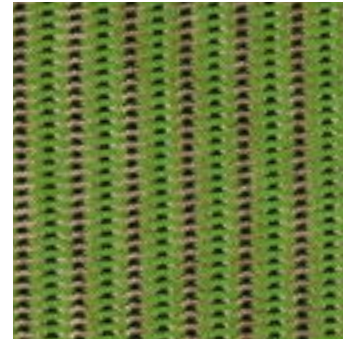

MOZART NEW
1C4K004 - Col. 165
140 CM - 55 IN
100%PL



SENESE NEW
1C4K007- Col. 160
135 CM - 53 IN
100%PP

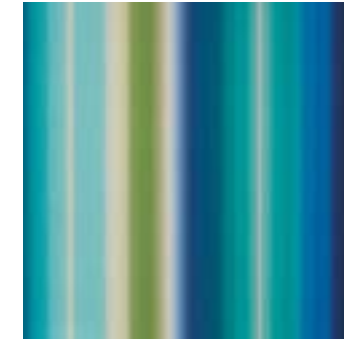

TONGA
1T4K003 - Col. 170
150 CM - 59 IN
100% PC

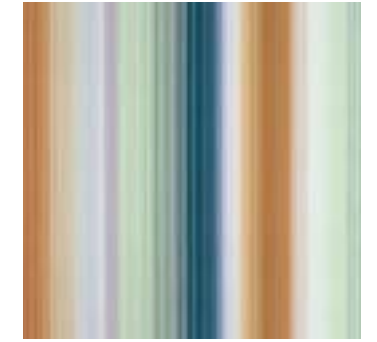

WONGA
1W4K010 - Col. 100
150 CM - 59 IN
100% PC



NOTTURNO NEW
1C4K006 - Col. 150
140 CM - 55 IN
100%PC



OCEANIA NEW
1C4K001 - Col. 100
145 CM - 57 IN
100%PC



RESORT NEW
1C4K002 - Col. 100
145 CM - 57 IN
100%PC

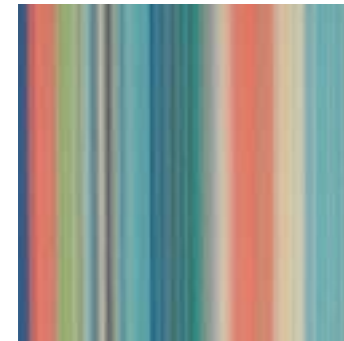

YUMBEL
1Y4K001 - Col. 100
145 CM - 57 IN
100% PC



RIVAS
1R4K006 - Col. 601
140 CM - 55 IN
100% PL



SAL
1S4K004 - Col. 48
145 CM - 57 IN
100% PC



SAL
1S4K004 - Col. 70
145 CM - 57 IN
100% PC

OUTDOOR



TENDE
SHEERS

SHEERS



A.F ●

WORCESTER

1W4TW01 - Col. 156

145x300 CM - 57x118 IN

100% PL



A.F ●

WORCESTER

1W4TW01 - Col. 174

145x300 CM - 57x118 IN

100% PL

